

# Evaluation of Algorithms for Randomizing Key Item Locations in Game Worlds

CALEB H. JOHNSON, JERRY L. TRAHAN<sup>1</sup>, (Member, IEEE),  
TAO LU, AND LU PENG<sup>2</sup>, (Senior Member, IEEE)

Division of Electrical and Computer Engineering, Louisiana State University, Baton Rouge, LA 70803, USA

Corresponding author: Lu Peng (lpeng@lsu.edu)

**ABSTRACT** In the past few years, game randomizers have become increasingly popular. In general, a game randomizer takes some aspect of a game that is usually static and shuffles it somehow. In particular, in this paper we will discuss the type of randomizer that shuffles the locations of items in a game where certain key items are needed to traverse the game world and access some of these locations. Examples of these types of games include series such as *The Legend of Zelda* and *Metroid*. In order to accomplish this shuffling in such a way that the player is able to reach the end of the game, some novel algorithms in graph theory must be utilized, where the game world and its item locations are represented as a graph and each edge on the graph has some rule for which items are required to traverse it. In this paper, we define these algorithms formally and evaluate them with different metrics that can guide a developer's decision about which algorithm works best for their game.

**INDEX TERMS** Game analysis, game randomization, graph theory.

## I. INTRODUCTION

A game randomizer is, in general, a modification of a game that randomizes some aspect of the game that is usually static. Many kinds of randomizers exist, such as randomizing enemy encounters, level up rewards, cosmetics, and item locations. In some types of games, usually belonging to the *Adventure* or *Metroidvania* genres, the player is required to find some items, abilities, or keys that allow them to move through the game world and access more locations where items can be found. Therefore, when randomizing the locations of items in a game like this, there must be some consideration for reachability.

The end goal of randomizing item locations in a game such as this is to ensure that the end of the game is reachable so that the player is able to complete it. For example, let's say there is a hammer item that is able to smash rocks that block the player's path, and the final area of the game is guarded by a rock the player must smash to proceed. If the hammer item is placed hidden underneath a rock, then the player will not be able to access the hammer and thus be unable to complete the game. Furthermore, let's say a different item is hidden under

that rock, and that item is required to access the hammer. The result is the same: the game will be uncompletable.

To accomplish our task of creating a completable placement of items within the game world, the world will be abstracted to a graph representation. Each node on the graph represents a location at which an item may be found, and each edge between a pair of nodes defines some rule that is required to traverse that edge. Utilizing this graph representation and the list of items currently in the player's inventory, a reachability graph can be calculated.

For the implementation, it will be useful to consider two kinds of nodes on the graph for organizational purposes: *regions* and *locations*. A region represents some space within the game world, such as the interior of a building. A location represents a single point within a region at which an item can be acquired. In the graph, regions connect to locations contained within them and to other regions that are directly accessible. Fig. 1 shows this distinction, with regions and locations as separate nodes on the left and the compressed view on the right, where a circular node denotes a location and a square node denotes a region. An important note is that edges between region nodes are not necessarily bi-directional. An edge could be one way, and oppositely directed edges can have different rules.

The associate editor coordinating the review of this manuscript and approving it for publication was Rupak Kharel<sup>1</sup>.

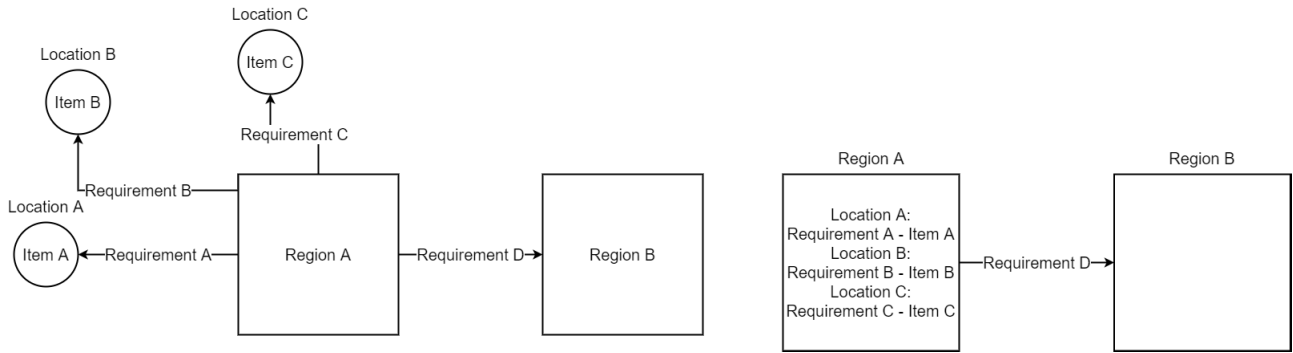

FIGURE 1. Detailed view of region and location graph nodes (left), compressed view showing locations as within regions (right).

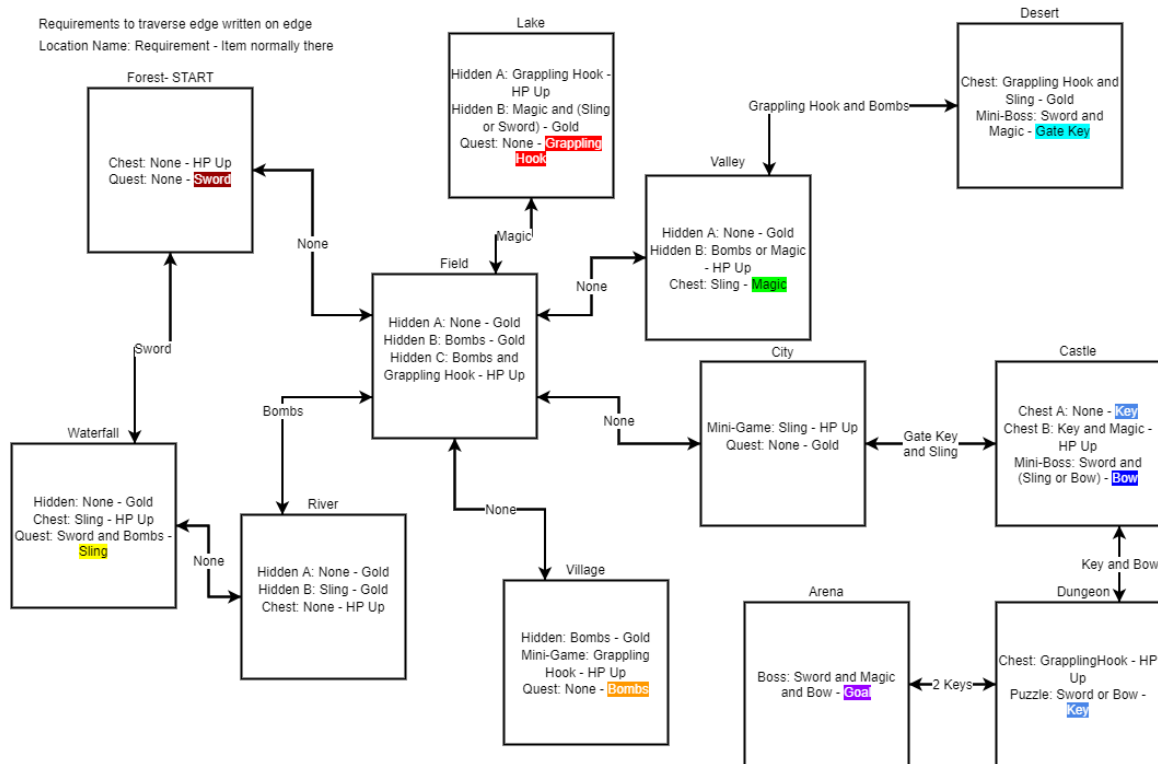

FIGURE 2. An example world graph with original item placements.

We describe three algorithms that utilize this reachability graph to fill empty item locations in such a way that will produce a completable result: Random Fill, Forward Fill, and Assumed Fill. Each algorithm has advantages and disadvantages, which will be evaluated in this paper.

Fig. 2 shows an example of a small game world graph that we designed to be similar to a real game world. Item placements shown here are the “original” placements, designed to be placed how items would be in a real game world, with key items highlighted in different colors. Refer to Fig. 1 to understand the meaning of elements of the graph. For example, to travel from Forest to Waterfall requires the sword item, and location Chest in Waterfall requires the sling. The player would start in Forest, in the top right, and eventually

make their way to Arena (second to the left from the bottom right) where the goal item is located. One can hand-trace a path through this world to eventually complete the game, travelling from region to region and collecting available item locations. Fig. 3 shows this same world but with the item locations randomized by Assumed Fill. One can still trace a path through this graph from the starting region to eventually be able to reach the goal and complete the game.

While we will use the term “item” for anything in the game that can be relocated and “key item” for an item that can be used to access new locations, within the game itself the item could be any number of things: a key, an ability, an upgrade, a tool, etc.

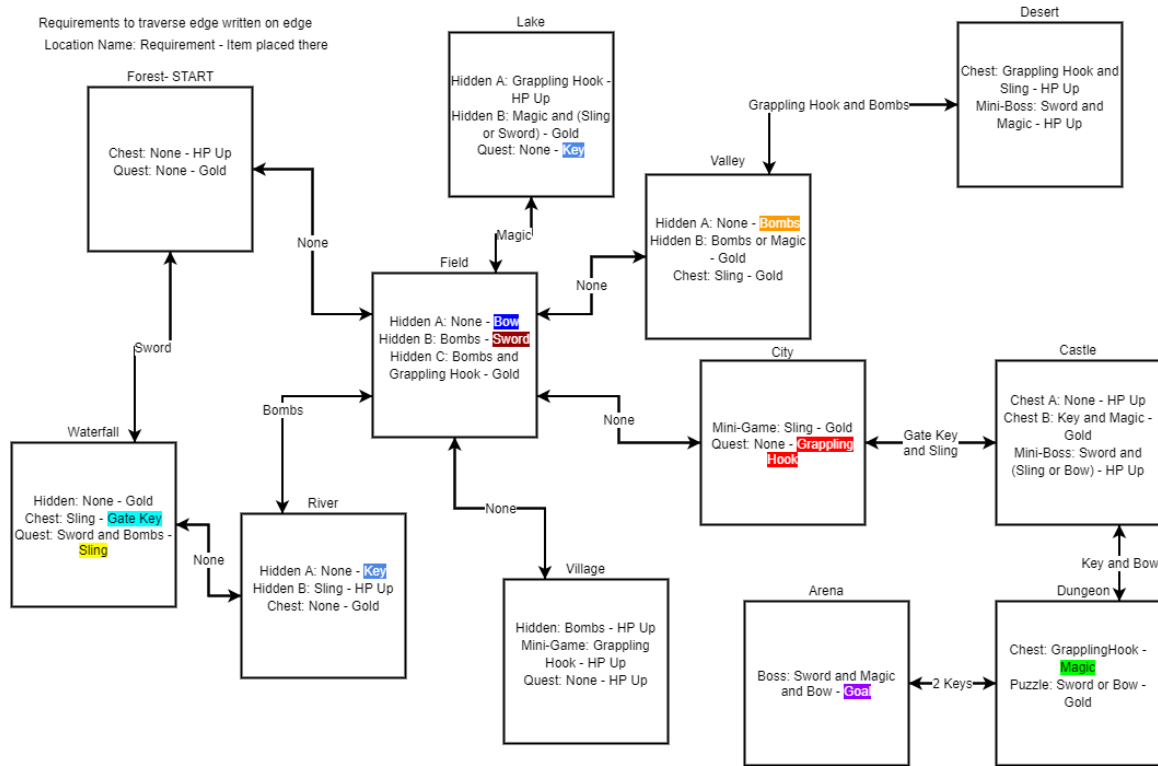

FIGURE 3. The same example world graph as Fig. 2 with item placements randomized by assumed fill.

Currently, most game randomizers exist as unofficial ROMHacks (modifications made to a compiled game executable which is distributed on Read Only Memory) of existing games. A recent game, *Bloodstained: Ritual of the Night*, includes a built-in randomizer. An older game, *Axiom Verge*, recently added a randomizer mode that started as a fan-made modification. As their popularity grows, more games that explore a world unlocking paths by collecting items could begin to incorporate randomizers as optional modes or even the main mode.

Game players can enjoy randomizers for several reasons. They are somewhat of a mid-point between adventure games, which typically have low randomization, and games where the entire world is randomized each playthrough. It ensures that every playthrough is unique, while at the same time allowing the player to have prior knowledge of the world’s layout and rules and where to look to make progress. They are popular both among casual players who simply want to replay a familiar game with a new experience, and racers or speedrunners who want to play the game repeatedly to beat it as fast as possible and desire a new experience each time. When one plays a randomizer for the first time, there is usually something of a shock factor that brings joy, such as finding an endgame item very early or a legendary item in an unassuming location.

Our motivation for this work, besides defining the algorithms used for key item placement randomization so that one can implement them, is to assess these algorithms with

different metrics in order to show some properties of their behavior and provide some guidelines on which algorithm works best for the game the randomizer is designed for. However, our work could potentially have application outside of computer games in other areas which utilize randomized or changing graphs such as networking, machine learning, or blockchain.

The layout of the rest of this work is as follows. Section II reviews some related work. Section III describes the three fill/item placement algorithms and several search algorithms in depth and formally defines them using pseudocode. Section IV describes our method to measure the complexity of a world and our method for generating world graphs. Section V defines the metrics that will be used to evaluate the algorithms, including the interestingness measure and its components. Section VI analyzes the results of these metrics based on the algorithm and world complexity used. Section VII discusses our work critically and mentions some possible future work. Finally, section VIII provides some concluding remarks.

## II. RELATED WORK

Ours is the first work researching algorithms for use in generating randomized item placement in game worlds, but we do have some related work to review.

Dormans and Bakkes [1] propose a somewhat similar work which represents a playable game area as a flowchart rather than a graph. A pair of actions such as finding a key and then

using that key to open a door are represented as finding the key being a step in the flowchart before the step of opening a door. In that sense this work also considers key items which must be acquired before accessing certain locations. However this paper is more focused on sequences of actions and generating such sequences to dynamically create enjoyable mission experiences in games and does not have consideration for changing the order of actions in a world which has already been created. Their mention of placing items where they will be needed soon also inspired the idea of the satisfyingness metric, one of the components of interestingness.

Cook and Raad [2] abstract actions that must be performed within a game to complete a level into a graph. However there are no edge rules in this graph which lock certain edges, and no consideration for reachability. The authors of this work find it useful to group some nodes together into hypernodes, similar to our method of grouping item location nodes into region nodes which are connected to each other.

Karavolos *et al.* [3] also abstract a game world as a graph, where nodes represent rooms, edges represent doorways between rooms, and a the value on a node represents what type of room it is in order to model dungeons in games. However, this work's focus is on generating graphs to make interesting dungeons to explore without consideration for locked edges and reachability. This paper instead had a much bigger influence on our work by their method of measure interestingness in a generated graph. While our methods of measuring interestingness are very different from theirs, their overall methodology of scoring different aspects and aggregating these scores for a final output greatly influenced our interestingness metric.

Liapis *et al.* [4] aim to generate interesting explorable spaces and mentions in their future work section the possibility of using directed graphs with lock and key mechanisms traversed with Breadth First Search. Their discussion of explorable spaces where backtracking is undesirable also influenced the mechanism for which our boredom metric, a component of interestingness, is measured.

Nugraha *et al.* [5] is a paper which creates a method to automatically place items in maps for First Person Shooter games using Convolutional Neural Networks. However, this paper is concerned with strategic and interesting placement of items that give the player an advantage for action-oriented purposes rather than logical placement for world traversal.

Several other papers inspired the creation of our interestingness metric and its individual components. Pederson *et al.* [6] gave the basic idea for our fun, challenge, and boredom metrics, especially their definition of fun where constant progress is being made by the player. Lehman and Stanley [7], mentioning novelty as a metric of evaluating interestingness of a game, gave the idea to incorporate bias into interestingness as more biased results for randomized worlds are more predictable. Roberts and Lucas [8] mention of desiring a challenge which is not too hard or too easy to

measure interestingness influenced our own challenge measurement where we desire a rate of finding key items which is not too often or too rarely.

While the fill and search algorithms (besides Playthrough Search) existed before the writing of this paper, they have not been formally defined anywhere, being discussed mainly in the comments of open source code files and online chat services used by randomizer developers [9], [10]. Perhaps the best source at the time of writing is a panel by randomizer developers where they discuss, among other topics related to randomizer development, the placement algorithms [11].

### III. ALGORITHM DESCRIPTIONS

Here we will formally define the algorithms used in generating and evaluating randomized world graphs. Subsection II.A describes algorithms used to fill the world graph with item placements while subsection II.B describes algorithms used to search a graph during and after it has been filled.

#### A. FILL ALGORITHMS

Also called item placement algorithms, these are the algorithms that are used to fill a given world graph using a given item set in order to create a completable result. These algorithms utilize the search algorithms given in the next subsection. Each of these algorithms is given an input graph  $G$ , which includes every location in the world at which an item can be found. A node in  $G$  initially has a null value, indicating that it is empty. When an item is placed in that node, that item is written to the node's value. Edges in  $G$  may require certain key items to traverse. Some other common variables used in these algorithms include:

- $R$ : Graph of reachable locations, a subset of  $G$ .
- $I$ : Set of key items currently owned, determines  $R$ .
- $I'$ : Set of key items not owned, the complement of  $I$ , also called the item pool.
- $Start$ : The starting node of  $G$ , search begins from this point.
- $Goal$ : The "end" node of  $G$ , reaching this node signifies completing the game. If  $Goal$  is within  $R$ , then the game is completable.

There are different kinds of items within a game. Our implementation considers the following types, in order of decreasing importance:

- *Goal Item*: This is the item contained at the goal node that signifies completion of the game when collected.
- *Key (or Major) Item*: This is an item that can allow the player to traverse an edge and is thus the main consideration for the fill algorithms.
- *Helpful Item*: This is an item that is helpful to the player but does not help them toward the goal of completing a game as far as graph traversal is concerned. This can include items such as more powerful weapons or HP (Hit Point) improvements which allow the player to take more damage before losing.

- *Junk Item*: This is an item that is either not helpful or only temporarily helpful. This can include items such as currency or ammo refills. Although our implementation differentiates between helpful item and junk items, the algorithms do not utilize this distinction. Sometimes, helpful items and junk items are collectively referred to as minor items.

### 1) RANDOM FILL

Here is the first and most basic fill algorithm. It works simply by placing each item in a random location in the world until all items have been placed. After distributing the items, a check is done to see if the game is completable. If not, the algorithm is repeated until a completable placement has been generated. It can be surmised that in a complex world it could take multiple thousands of attempts to complete. Algorithm 1 describes Random Fill. Lines 1 and 3-6 are just for initialization before the loop and on repeat attempts. The second while loop beginning on line 7 is where the item placement occurs. After that, R is computed to check if it contains the goal. If not the world graph and item pool are reset and the placement is attempted again.

Usually when Forward Fill or Assumed Fill are utilized they are used on only the key items and then Random Fill is used to place helpful and junk items that do not affect completable.

We will now discuss the time complexity. For the fill algorithms,  $n$  equals the number of key items to distribute. Sphere Search is an algorithm that will be discussed more in-depth in subsection III.B.3, but for now know that it is an algorithm to check completable of an item distribution.

A single iteration of Random Fill takes  $O(n(|V| + |E|))$  time for Sphere Search and  $O(n)$  time for the remainder, since it must loop once for each item to place in the world. The best case is only one iteration to compute a correct result. We must consider the expected performance, however. If the world graph contains  $|V|$  vertices, then the number of possible orders for filling those locations is  $|V|!$ . The number of completable placements depends on the exact world graph. A more complex world will generally have fewer completable placements, which is verified in Section VI. If the number of completable placements is constant, then the expected time for Random Fill to compute a completable result is  $O(|V|!(n(|V| + |E|)))$ .

### 2) FORWARD FILL

Next we consider Forward Fill. This is the first of two algorithms that fill the world intelligently by considering the rule on each edge, however, it is still fairly simple to understand and implement. It initializes R to be the set of reachable locations from the beginning of the game. It then chooses a random item from the item pool I' (line 5) and places it in a random location within R (line 6), also adding that item to I (line 7). This location is then removed from consideration and all locations that become reachable are added to R through the generalized search algorithm. This process is repeated until

---

#### Algorithm 1: Random Fill

---

```

Input : Empty world graph G, item pool I', Goal
Output: Completable world graph G
1 I = Empty;
2 while R does not contain Goal do
3   G.Reset();
4   I'.Add(I);
5   I'.Shuffle();
6   I = Empty;
7   while (G has nodes with null value) and (I' is not
      empty) do
8     g = Random null node in G;
9     i = I'.Pop();
10    g.Value = i;
11    I.Add(i);
12  end
13  R = SphereSearch(G, Start);
14 end
15 return G;

```

---



---

#### Algorithm 2: Forward Fill

---

```

Input : Empty world graph G, item pool I', Goal
Output: Completable world graph R
1 I = Empty;
2 I'.Shuffle();
3 while (R has nodes with null value) and (I' is not
      empty) do
4   r = Random null node in R;
5   i = I'.Pop();
6   r.Value = i;
7   I.Add(i);
8   R = Search(G, I, Start);
9 end
10 Return R;

```

---

all items have been placed. Algorithm 2 describes Forward Fill.

Like in Random Fill, the while loop iterates for each item given, and for our time complexity consideration  $n$  equals the number of key items to distribute. However each iteration must also perform the search algorithm, which itself has a complexity of  $O(|V| + |E|)$  as it is a modification of Breadth First Search (see Section III.B). Therefore the time complexity of Forward Fill is  $O(n(|V| + |E|))$ .

### 3) ASSUMED FILL

Finally we will consider Assumed Fill. This is the most complex algorithm to understand and implement, as well as having the highest time complexity for a single iteration. Assumed Fill begins by assuming the player initially has access to all items, meaning reachable locations R is equal to the entire world graph G (line 4). In the inverse of the other two algorithms, I is thus initialized to the set of all items and I' is set to be empty (lines 1-3). A random item is removed from I in line 6, meaning that R will shrink (rather than expand



**Algorithm 3:** Assumed Fill

---

**Input** : Empty world graph  $G$ , item pool  $I$ , Goal  
**Output**: Completable world graph  $R$

- 1  $I = I'$ ;
- 2  $I.Shuffle()$ ;
- 3  $I' = \text{empty}$ ;
- 4  $R = G$ ;
- 5 **while** ( $R$  has nodes with null value) and ( $I$  is not empty) **do**
- 6      $i = I.Pop()$ ;
- 7      $R = \text{AssumedSearch}(G, I, \text{Start})$ ;
- 8      $r = \text{Random null node in } R$ ;
- 9      $r.Value = i$ ;
- 10     $I'.Add(i)$ ;
- 11 **end**
- 12 **Return**  $R$ ;

---

as it does in Forward Fill). A random empty location that is still reachable is then selected and the item is placed there (lines 8 and 9). The way this algorithm begins by assuming the player has all items and removes them can be thought of as the opposite of Forward Fill. Algorithm 3 describes Assumed Fill.

Assumed Fill does come with a special consideration for its search function, as to work fully it must account for the case where an item is removed from  $I$  but is still within  $R$ . This will be looked at more closely in the following subsection where we define the search algorithms.

Like Forward Fill, the while loop iterates once per each key item and each iteration must perform the search function. However, Assumed Fill's modified search executes multiple search iterations (see Section III.B), up to the same number of key items given, adding another degree onto Assumed Fill's time complexity, which is thus  $O(n^2(|V| + |E|))$ .

**B. SEARCH ALGORITHMS**

Now we will consider the search algorithms that the fill algorithms use and that we use to analyze the resulting filled game worlds. The first three are utilized when generating a filled world graph and checking the result and function as an algorithmic search is expected to work. The last is meant to be an approximation of a player moving through the game world in order to calculate some information about how a generated world would feel to play.

**1) GENERALIZED REACHABILITY SEARCH**

First we consider our generalized search algorithm which computes a reachability graph given an input world graph, set of items currently owned, and the starting node. This algorithm is basically a modification of Breadth First Search that checks if an edge is traversable before adding to the queue the node to which that edge leads on line 10. Edges that are traversable and nodes which are reachable are added to an initially empty graph in order to construct a full reachability

**Algorithm 4:** Search

---

**Input** : World graph  $G$ , owned items  $I$ , Start  
**Output**: Reachability graph  $R$

- 1  $R = \text{Empty}$ ;
- 2  $\text{Queue} = \text{Empty}$ ;
- 3  $\text{Queue.Enqueue}(\text{Start})$ ;
- 4  $\text{Visited} = \text{empty}$ ;
- 5  $\text{Visited.Add}(\text{Start})$ ;
- 6 **while**  $\text{Queue}$  is not empty **do**
- 7      $r = \text{Queue.Dequeue}()$ ;
- 8     **for**  $\text{edge}$  in  $r$  **do**
- 9          $\text{target} = \text{node edge leads to}$ ;
- 10        **if**  $\text{RequirementsMet}(\text{edge}, I)$  and ( $\text{Visited}$  does not contain  $\text{target}$ ) **then**
- 11             $\text{Queue.Enqueue}(\text{target})$ ;
- 12             $\text{Visited.Add}(\text{target})$ ;
- 13        **else if not**  $\text{RequirementsMet}(\text{edge}, I)$  **then**
- 14             $r.Remove(\text{edge})$ ;
- 15        **end**
- 16     **end**
- 17      $R.Add(r)$
- 18 **end**
- 19 **Return**  $R$ ;

---

**Algorithm 5:** Assumed Search

---

**Input** : World graph  $G$ , owned items  $I$ , Start  
**Output**: Reachability graph  $R$

- 1 **while**  $\text{NewItems}$  is not empty **do**
- 2      $R = \text{Search}(G, I, \text{Start})$ ;
- 3      $\text{NewItems} = R.GetItems() - I$ ;
- 4      $I.Add(\text{NewItems})$ ;
- 5 **end**
- 6 **Return**  $R$ ;

---

graph, which is then returned. Algorithm 4 shows this reachability search.

As this algorithm is a modification of Breadth First Search, it has the same time complexity of  $O(|V| + |E|)$ , assuming the lookup time of visited nodes is equal to  $O(1)$ . This could be accomplished with an array of Booleans indicating whether each node has been visited.

**2) ASSUMED SEARCH**

Assumed Fill utilizes a slight modification of the generalized search algorithm as it must consider the case when an item has been removed from  $I$  but is still within  $R$ . Therefore it utilizes the generalized search algorithm to find a reachability graph, takes any items found within, then runs the search again (loop starting line 1). Further iterations of finding items within  $R$  may expand  $R$  more, meaning Assumed Search could potentially run as many times as there are key items placed within it, so the complexity of this algorithm is the number of items  $n$  multiplied by the complexity of the general search algorithm,  $O(n(|V| + |E|))$ . Algorithm 5 shows Assumed Search.

### 3) SPHERE SEARCH

Now we will discuss sphere search. This algorithm is given a world that has already been filled and an initially empty item set  $I$ . The goal of this algorithm is to produce a list of reachability graphs, called spheres, which iteratively discover reachable locations. This list is called  $S$ . This task is accomplished, somewhat similar to Assumed Fill, by performing the generalized search, adding all new items from that search, and repeating this process until an iteration is performed in which no new locations are discovered. This indicates the search has either reached a dead end or all locations have become reachable (including the goal node). Algorithm 6 shows Sphere Search.

There are two main purposes for this algorithm. The first is simply to check whether a world placement is completable by checking if the goal node is contained within the last sphere in the list. While the goal node could be discovered before the last sphere, each sphere is a subset of the following sphere, so if it's discovered at all it will be in the final sphere. The second is to produce a list of progress locations that the player can access in the same order to complete the game, something of a guide for how they can complete the game if they get stuck, though it will rarely be the most efficient path through the game.

The following text is an example of a sphere search tracing an output to the end of the game world shown in Fig. 3. While each sphere contains all location-item pairs from the previous spheres, sphere lists are usually printed such that only location-item pairs that are new in each sphere are displayed.

```
Sphere 0:
Field_Hidden A: Bow
Valley_Hidden A: Bombs
City_Quest: GrapplingHook
```

```
Sphere 1:
Field_Hidden B: Sword
River_Hidden A: Key
```

```
Sphere 2:
Waterfall_Quest: Sling
```

```
Sphere 3:
Waterfall_Chest: GateKey
```

```
Sphere 4:
Dungeon_Chest: Magic
```

```
Sphere 5:
Lake_Quest: Key
```

```
Sphere 6:
Arena_Boss: Goal
```

As sphere search must iterate potentially once for each item and each iteration performs the general search algorithm, its

---

### Algorithm 6: Sphere Search

---

```
Input : World graph G, Start
Output: List of spheres (graphs) S
1 S = Empty;
2 I = Empty;
3 while new locations discovered do
4   s = Search(G, I, Start);
5   NewItems = s.GetItems() - I;
6   I.Add(NewItems);
7   S.Add(s);
8 end
9 Return S;
```

---

time complexity equals  $O(n(|V| + |E|))$ . This is the same as assumed search. Assumed search and sphere search have very similar functionality, but produce different results.

### 4) PLAYTHROUGH SEARCH

The final search algorithm we will consider is Playthrough Search. This algorithm is not utilized within the fill algorithms but is instead used to extract some metrics about how a playthrough of a certain world graph may look in order to determine how interesting that placement of items is. Playthrough Search thus attempts to act as a player would when traversing the game world.

It was mentioned in the introduction that we consider two types of nodes on the graph, regions and locations. A region is a space within the game world, such as a room or a town, while a location is a single point within that space that contains an item. The previous algorithms were agnostic to this distinction, considering only locations. However, for a playthrough, this differentiation is useful. The player will exist within a certain region, collect all locations available to them within that region, and then move to the next region and collect all locations there. In order to decide which region the player should move to next, a heuristic is used. We will first consider the algorithm with a generic heuristic. Algorithm 7 shows Playthrough Search. Each iteration of the while loop is one traversal. Items are collected during this traversal and the heuristic is used to determine which region the player will occupy on the next traversal (lines 5 and 6).

The heuristic is used to determine which region the player would most strongly desire to move to next. The heuristic function returns a list of scores for each edge leading from the current region to a different region. The region that has the maximum score is then set as the current region for the next iteration of the loop.

This algorithm has a couple of uses. Like sphere search, it can be used both to determine if a given world is completable and to extract a sequence of item collections that will lead to the completion of the game. It could be argued that this sequence is more useful than that given in sphere search since it behaves closer to a player. It can also be used to extract metrics from the playthrough that can be utilized to determine properties of the given placement of items, mainly

**Algorithm 7:** Playthrough Search

**Input:** World graph G, Start  
 1 Current = Start;  
 2 I = Empty;  
 3 **while** world has available locations that have not been checked **do**  
 4     I.Add(all available locations within Current);  
 5     ScoreList = Heuristic(G, Current.Edges, I);  
 6     Current = Region led to by edge with max score;  
 7 **end**

how interesting it is. These metrics will be discussed more in depth in Section V.

We will now define the heuristic we used for our implementation of this algorithm. This heuristic was created with the following assumptions of the player, which are typical of players of randomizers [12].

- 1) The player has complete knowledge of the game world, so they always know where available item locations they have not yet searched can be found.
- 2) The player will consider both the number of available locations in each direction as well as proximity of these locations when deciding to which region to travel next.
- 3) The player will attempt to avoid backtracking and instead be more likely to seek out new regions or regions that have been visited less recently.
- 4) The player is more likely to visit a region if it is a “dead end”, meaning it has only a single edge that is attached to the current region. In terms of the game, this would be like poking into a single-room building quickly to grab something.

Based on these assumptions, our heuristic uses the following rules to score every exit attached to the current region by considering the world graph as a whole, which locations have already been searched, and which locations are available with the given item set. Numbers used within these rules were fine-tuned through experimentation to give traversals that were reasonable to player behavior and reactive to different item placements.

- The heuristic will search each edge using Depth First Search. Each region visited will receive an individual score that equals the number of available, non-empty (not yet searched) locations in that region divided by the distance from the current region. However, this divider maxes out at 8, so that regions far away are not completely discounted if they contain a cluster of many available locations. The exit’s score is then set to the sum of these individual scores. This satisfies assumptions 1 and 2.
- A list keeps track of every region visited. The previous 16 visited regions will receive a penalty by their score receiving a divider (minimum 1) equal to 17 - k, when the considered region was visited k traversals ago. This means the most recently visited region will have its score divided by 16, the 2nd most recently visited region

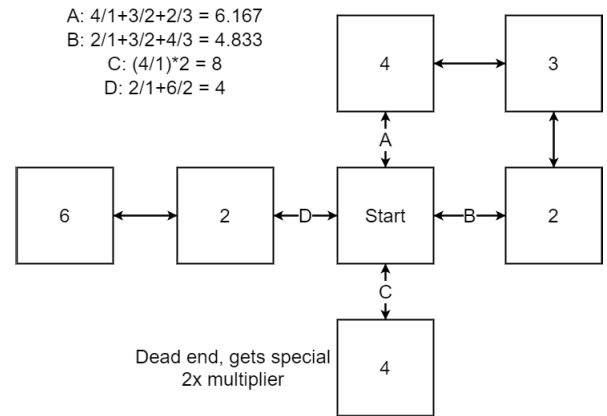

**FIGURE 4.** Example of our heuristic for Playthrough Search. The number in each region shows the number of available locations in that region.

will have its score divided by 15, etc. This satisfies assumption 3.

- Finally, if the region is a dead end, which is simply found by checking if no other edges lead out of the region, it will receive a 2x multiplier so that the player is more likely to check it. This satisfies assumption 4.

For an example of this heuristic, see Fig. 4. Exit C will be visited first as it has the highest score, then move back to start. The scores will then be evaluated again but exit C’s score will be 0 as all of its available locations have been searched. Exit A will then win instead, because although the path through exit A visits the same regions as exit B, exit A has more locations in closer proximity. After moving through the three regions in the upper right, the search will finally move toward exit D and fully search all locations within this graph.

**IV. WORLD COMPLEXITY AND GENERATION**

For this research, we want to not only study the properties of the output and performance of the different fill algorithms, but also study the effect the world itself can have on these. The size and complexity of a game world can vary greatly, from small games that take only a few hours to complete to games that are expected to take 40+ hours to finish. Therefore we must have some way to measure the complexity of a given world graph. This section goes over how we accomplish this, as well as our method of generating randomized worlds to use for testing purposes.

**A. INDIVIDUAL LOCATION COMPLEXITY SCORE**

When normally assessing the complexity of a graph, one may consider the number of nodes and edges. For our purposes, complexity is less a representation of the size of the graph and more of how difficult it is to move through the graph. We expect a more complex world to have a higher chance to fail to generate a completable placement for Random Fill, as the likelihood of an acceptable placement decreases. Therefore we must create our complexity measure so that it considers the rules on each edge of the graph.



To accomplish this, we observe each location within the game world and construct what we call a *total rule*. A total rule includes not only the rule on the edge between a location and its encompassing region, but also all of the rules that are required to reach that region. Thus, we set a total rule for each location that incorporates the location's individual rule AND the rule for each path to that region. The rules along the path from the start region to the target region are ANDed to create a path rule, and each of these path rules are ORed.

For a location  $L$  contained within an encompassing region, let  $p_i = \langle r_{i,0}, r_{i,1}, \dots, r_{i,k(i)} \rangle$  denote the  $i$ th path from the start region to the encompassing region, where  $r_{i,0}$  is the start region and  $r_{i,k(i)}$  is the encompassing region. Let  $q$  denote the number of such paths, and let *RelativeRule* denote  $L$ 's rule relative to its encompassing region. The total rule for a location  $L$  can be represented by the following formula:

$$\text{RelativeRule} \wedge \bigvee_{i=0}^{q-1} \bigwedge_{j=1}^{k(i)} \text{rule from } r_{i,j-1} \text{ to } r_{i,j} \quad (1)$$

An example of this can be seen graphically in Fig. 5.

These paths are calculated using Depth First Search and once the total rule is found, it is simplified with Boolean statement simplification methods. Each total rule is then scored using the following criteria:

- Start with each rule having a base complexity of 1
- Each key item requirement adds 1 to the complexity
- An AND adds.5 complexity since it makes the rule harder to satisfy
- An OR subtracts.5 complexity since it makes the rule easier to satisfy

By doing this calculation on each location within the world graph, a list of individual location scores can be obtained. But now the question is how to calculate a final score given this list of scores. After some thorough evaluation utilizing the world generation, we decided to take the average of the top 50% of individual scores to produce the final complexity score. Using the top 50% makes it so having many easy to reach locations near the beginning of the game world does not obscure the true complexity of the harder to reach areas, which is what really determines how difficult it is to move through the game world. We decided against summing these scores as having more locations does not necessarily add complexity, but the score grows very quickly using this method.

## B. WORLD GENERATION

For our research we desire a method to generate world graphs given a couple of baseline inputs. These generated worlds were originally used to evaluate different possible metrics for scoring complexity but their main use is for testing purposes. We will now describe our generation process.

The world generator is passed two arguments: number of regions to generate and number of key items. It begins by generating a list of regions (named Region-0, Region-1, Region-2, etc.) and a list of key items (named simply A, B,

C, etc.). The first region is designated as the start region, the second region is generated as the hub region (a very common practice in game design is to have a hub region) and the final region is designated as the goal region. Each edge and item will have a rule composed of no, one, or more requirements.

If two regions are directly connected, then they will have a pair of oppositely directed edges between them. For simplicity, these edges' rules will be equal. For each type of region, we describe below the creation of certain outgoing edges and their rules. For each such edge, Table 1 gives the probability distribution of requirements for the rule for the pair of incoming and outgoing edges.

The start region is generated in the following manner. It is guaranteed to have an outgoing edge (exit) to the hub region with no requirement, an outgoing edge to a random region with one item requirement, and a 50% chance of an outgoing edge to a third region with a 50% chance between having no requirement or requiring a single item. It is also generated containing three item locations with no requirement and a 50% chance of a fourth location with one requirement.

The hub region also has special rules for generation. It will always generate with six outgoing edges, three of which have no requirement (one of these leads to the start region) and three which have a single requirement. It also generates with two item locations with no requirement, one with one requirement, and one with two requirements.

The final region has no special rules for number of outgoing edges but each incoming edge will require every key item in the world to traverse. While a game may not necessarily require every key item to reach the end, typically most if not all are required. The final region will also contain a single item location, which contains the goal item, the collection of which signifies completion of the game.

Other regions are generated in the following manner. Each will generate one or two outgoing edges (50% chance of each) with a random rule according to Table 1 and will allow a maximum of four outgoing edges including edges generated by other regions. (Note: When a region generates an outgoing edge to a random destination region, it considers only regions with fewer than four connections as possible destinations.) Each region will generate two, three, or four (each equally likely) item locations with a randomly generated rule.

Rules are randomly generated in the following manner. A one requirement rule will simply choose a single key item from the item list that will be the requirement. A two requirement rule will choose two key items (not the same one) and have a 50% chance each for them to be joined with AND or OR. A three requirement rule just generates a two requirement rule and a one requirement rule (making sure the item in the one requirement rule is not redundant with the two requirement rule) and again randomly joins them with either AND or OR.

There is also a chance to generate a complex requirement. A complex requirement will generate two or three (50% chance each) clauses, where a clause has a 20% chance to

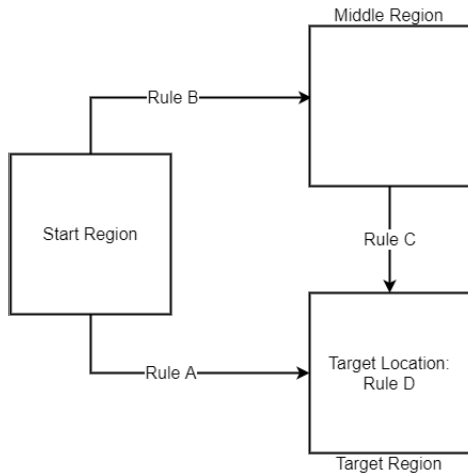

FIGURE 5. Example of formula for a total rule.

Total Rule = ((Path from Start to Target) or (Path from Start to Middle to Target)) and Relative rule

Total Rule = ((Rule A) or (Rule B and Rule C)) and Rule D

Relative rule: Rule D

TABLE 1. Chance of generating each type of rule for item locations and edges.

Rule Type	Item Location	Edge
No Requirement	20%	60%
One Requirement	40%	20%
Two Requirements	20%	10%
Three Requirements	10%	5%
Complex Requirement	10%	5%

be a single requirement, and a 40% chance each to require two or three items joined by a random selection of AND or OR.

The distribution of requirement probabilities for item locations and edges is shown in Table 1. We decided that edges should be more generous since an exit (outgoing edge) is often simply an open doorway the player can freely walk through.

After all of the previous steps, two finalizing steps are performed. First, we make sure the graph is connected by checking if all regions have a path to them from the start region. If not, more edges are added to make the graph connected. Next, a number of junk or helpful items (50% chance of each) equal to the number of generated locations minus the number of key items are generated and added to the item list. This ensures that there is a possible item for every location in the game world. We believe our method produces worlds which are comparable to real game worlds [1].

C. WORLDS GENERATED FOR ALGORITHM EVALUATION

Using our world generation method, we generated five worlds of increasing complexity to use in testing. Table 2 shows some properties of these worlds. Keep in mind that the region count and item count were input parameters to the generation, while the number of item locations and the final complexity score were a result of the generation. These input parameters were chosen to give increasing complexity in a desirable manner.

TABLE 2. Testing world properties.

Name	Region Count	Item Count	Locations	Complexity
World 1	10	5	26	4.31
World 2	25	10	74	11.11
World 3	35	15	105	22.25
World 4	45	20	135	32.63
World 5	50	30	143	53.23

To ensure these worlds were not outliers, 100 worlds with the same input parameters were generated and their average complexity calculated. The worlds used here had complexity within 10% of these average values.

V. DESCRIPTION OF ALGORITHM EVALUATION METRICS

In this section we will define the different metrics by which we evaluate the algorithms’ performance and results.

A. FAILURE RATE

Defining failure as generating a world that is not completable, all of our item placement algorithms have a chance of failure. Random Fill can fail many times before producing a successful result. Forward and Assumed Fill, on the other hand, should almost never fail, although they can in certain situations. Fig. 6 shows an example of a situation where Forward Fill may be very likely to fail. Since the start region leads from a single edge locked by Item A and has only three available locations, if Item A is not one of the first three items selected to be placed, then the algorithm would fail. In a situation like this, a randomizer developer may choose to hard-code it such that Item A is placed before any other items to avoid failure.

While we expect the failure rate for Forward and Assumed Fill to be very small to the point of being almost negligible, we expect the failure rate of Random Fill to grow quickly as the complexity of the graph increases, which is supported by our results in Section VI.

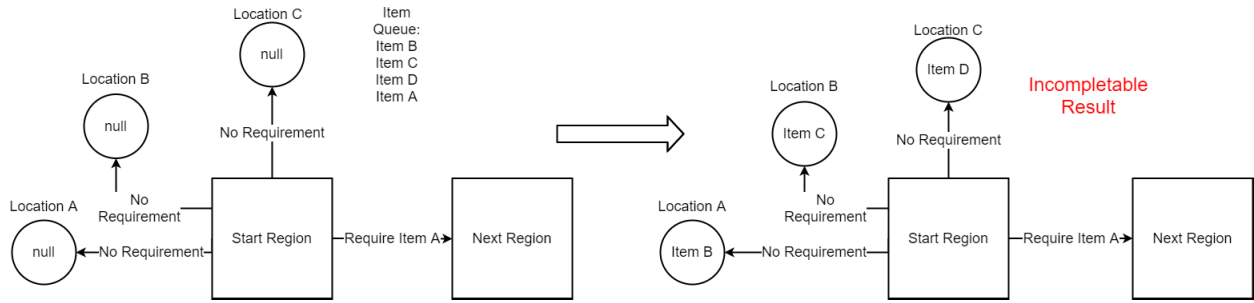

FIGURE 6. Example of a graph where forward fill is likely to fail.

**B. EXECUTION TIME**

For each iteration of each algorithm on each test world we will measure the execution time to complete that iteration. We expect that for a single iteration, the increasing order of execution time will be Random, Forward, then Assumed Fill. We also expect the execution time to increase as world complexity increases.

For the fill algorithms, however, we have another consideration for execution time, that is the failure rate. Especially for Random Fill, the time of a single iteration does not tell the whole story if the algorithm must potentially be run multiple times to produce a completable result. Therefore we will also compute an expected execution time that multiplies the execution time for a single iteration by the reciprocal of the success rate, which is simply 1 minus the failure rate. This gives the expected time to produce a completable world placement. For example, if an algorithm has a 50% failure rate, then it is expected that it will have to be run twice to generate a successful placement, so we multiply the execution time for a single iteration by 2. We expect that the adjusted execution time will go in increasing order of Forward, Assumed, then Random Fill. However, for the less complex worlds there is possibly a chance that Random Fill could still be faster than the others.

**C. BIAS**

Bias is the propensity of a fill algorithm to cluster more key items together, in terms of progress through the game world, typically toward the beginning of the game. Basically, in an algorithm such as Forward Fill, the first several spheres of a sphere search are likely to contain a disproportionately high number of key items.

The calculation of bias is fairly simple. After a successful world placement is generated, a sphere search is performed. (This could be done on an unsuccessful placement as well, but this would not be a very relevant or helpful metric.) Each sphere subtracts the fraction of new locations within that sphere (relative to the total number of locations in the game world) from the fraction of new key items in that sphere (relative to the total number of key items). The absolute value of this number is added to a sum for each sphere. (If absolute value was not taken, the sum would always equal 0 by the end.) This sum is then divided by the number of spheres

for normalization. This value then gives a good general idea for how clustered together the key items are in the overall progression.

We will also measure a bias direction, by keeping separate sums before and after the middle sphere that do not take the absolute value of each sphere’s individual bias. By checking which sum (the sum before or after the middle) is higher, it can be determined if the bias is more toward the beginning or more toward the end of the game progression. We expect it to almost always be toward the beginning, especially for Forward Fill.

Bias is a metric that has been discussed by randomizer developers before the writing of this paper as a reasoning to use one algorithm over another. It is also a very objective measure compared to interestingness and its other metrics as it does not utilize the somewhat subjective PlaythroughSearch to calculate its result. However, ours is the first work to quantitatively measure bias as a function of the algorithm used and complexity of the world graph used.

**D. INTERESTINGNESS**

Interestingness is a metric that attempts to capture the overall quality of a placement by a numeric score from a generated world graph. Interestingness includes five considerations, each a floating point number in the range [0, 1] and weighted at 20% to produce a final value:

- Bias (Lower is better)
- Fun (Higher is better)
- Challenge (Higher is better)
- Satisfyingness (Higher is better)
- Boredom (Lower is better)

Therefore the formula for interestingness is equal to  $0.2[(1 - \text{bias}) + \text{fun} + \text{challenge} + \text{satisfyingness} + (1 - \text{boredom})]$ .

Bias has already been discussed in the previous subsection. The decision to include bias in interestingness, considering more biased worlds result in more predictability, was influenced by Lehman and Stanley [7]. We will now discuss the other four metrics in depth. Each of these four measures is based on information extracted from Playthrough Search on the given world graph. Numbers used for the calculation of these metrics were fine-tuned through experimentation

to give results within a reasonable range and that varied depending on the generation.

The overall idea of utilizing different individual interestingness metrics and aggregating them to create a final score was influenced by Karavolos *et al.* [3].

### 1) FUN

Fun is a metric meant to represent the player consistently making progress by discovering item locations. Hopefully at least one location is discovered for every traversal to keep up consistent progress. From Playthrough Search, we extract a list of how many new locations are searched per traversal.

Fun is then calculated in the following manner. A loop goes through this list and maintains a rolling average of the last five traversals. If this average is greater than or equal to 1, a true value is added to a list of Booleans. If it is less than 1, a false value is added. This rolling average gives a better representation for how many items the player is currently finding, even if they go one or two traversals without finding any during a high rate of searching, or occasionally find one or two during a low rate. The final score for fun then equals the fraction of true values within this list.

The idea for measuring fun by the player making constant progress was inspired by Pederson *et al.* [6].

### 2) CHALLENGE

Challenge is a metric to represent the rate at which the player obtains key items (thus unlocking more of the world) being not too often or too rarely. Playthrough Search gives us a list of how many traversals the search did between finding each key item.

Challenge is then calculated as follows. We first get an optimal traversal value by dividing the number of locations in the world by the number of key items so that our range is relative to the number of locations in the world. The lower threshold is then set to the floor of 50% of this number, while the upper threshold is set to the ceiling of 150% of this number. Similarly to the fun calculation, we then iterate through the list and find the fraction of values in the list within this desirable range (inclusive) using a slightly tighter rolling average of the last three values. The final challenge score is then this fraction.

The idea for challenge being represented by the rate at which key items were found was inspired by Pederson *et al.* [6] and the idea that a desirable rate should be within a range that is not too low or high was given by Roberts and Lucas [8].

### 3) SATISFYINGNESS

Now we discuss satisfyingness. This metric is meant to represent, once the player acquires a new key item, how satisfying is it to find this. We define satisfying as how immediately useful the item is, as it feels good for the player if they find something that unlocks a large chunk of the world at the same time. From Playthrough Search we extract a list of how many new item locations are unlocked every time a key item is found.

Satisfyingness is then calculated in the following manner. Unlike fun and challenge, it does not use a rolling average. Like fun and challenge, we set a threshold and look for the fraction of values in the list that are greater than or equal to this threshold. We set the threshold to the floor of the number of locations in the world (disregarding those that are immediately available, since these should not factor into how satisfying it is to unlock new locations) divided by the number of key items.

Satisfyingness being measured as how immediately useful a key item is at the time it is found was inspired by Dormans and Bakkes [1].

### 4) BOREDOM

The final metric for interestingness is boredom. Like bias, lower boredom is better. Boredom measures regions that are visited more often than usual throughout the playthrough. Our heuristic for Playthrough Search was constructed to try to avoid backtracking, but more backtracking is inevitable as world complexity increases. From Playthrough Search we have a list of how many times each region was visited.

Like the other interestingness metrics besides bias, we inspect each value in this list and set boredom equal to the fraction of these values greater than (rather than greater than or equal to, to be slightly more generous) a threshold. Here the threshold is set as the ceiling of the average number of traversals per region.

The idea to incorporate a boredom metric was given by Pederson *et al.* [6] and measuring it as the amount of backtracking the player must do to complete the game was influenced by Liapis *et al.* [4].

## VI. EXPERIMENTAL RESULTS

In this section we will describe the setup and results of our experimentation to evaluate the performance and output of each algorithm relative to each other and to the complexity of the input world graph.

### A. EXPERIMENTAL SETUP

Our implementation was coded in C# and run on a Windows machine with an AMD Ryzen 9 3900x processor and 32GB of DDR4 RAM. Each algorithm was performed on each of the 5 input worlds 100,000 times (for a total of 1.5 million trials). On each trial, the following information was recorded within a SQLite database:

- Which algorithm was used
- Which world was used
- Execution time (of the fill algorithm only)
- Whether the result was completable
- Bias score
- Bias direction
- Interestingness score
- Fun score
- Challenge score
- Satisfyingness score
- Boredom score

**TABLE 3. Failure rate per algorithm per world (% failed).**

Algorithm Used	World 1	World 2	World 3	World 4	World 5
Random Fill	85.943%	97.619%	99.488%	99.945%	99.885%
Forward Fill	0%	0%	0%	0%	0.725%
Assumed Fill	0%	0%	0%	0%	0.002%

**TABLE 4. Single-iteration execution time per algorithm per world (ms).**

Algorithm Used	World 1	World 2	World 3	World 4	World 5
Random Fill	0.037	0.231	0.438	0.746	0.801
Forward Fill	0.266	1.113	2.776	5.224	9.645
Assumed Fill	0.754	4.126	14.021	26.810	63.995

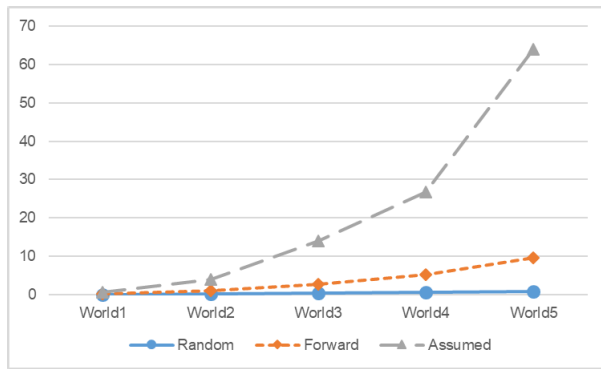

**FIGURE 7. Average execution time per algorithm per world (ms). Lower is better.**

Randomness is provided by C#'s default random class, which utilizes Donald E. Knuth's subtractive random number generator algorithm. The implementation can be viewed on GitHub [13].

**B. RESULTS AND EVALUATION**

Results for the failure rate are shown in Table 3. It can be seen that the failure rate for Random Fill increases as the complexity of the world increases, except for the change from World 4 to World 5, where the failure rate actually decreases. On the other hand, Forward Fill and Assumed Fill have a 0% failure rate up until World 5, where they both have a very small percentage of failures, with Forward Fill having more than Assumed Fill.

Upon inspection of World 5, it was found that the goal region was placed connected to the hub region. (While this may seem strange, this is actually not uncommon game design.) Perhaps having that early edge locked with a very difficult lock made it so Forward Fill was more likely to get stuck early on when generating item placements. Random Fill, on the other hand, seemingly benefits from having the final region close to the start of the game.

Next is the execution time, shown in Table 4 and Fig. 7. It can be seen that while the time in World 1 is fairly similar for all three algorithms, Assumed Fill quickly grows in execution time faster than Forward Fill which grows faster than Random Fill. This is due to Assumed Search requiring

**TABLE 5. Expected execution time per algorithm per world considering failure rate (ms).**

Algorithm Used	World 1	World 2	World 3	World 4	World 5
Random Fill	0.261	9.723	85.600	1356.551	696.269
Forward Fill	0.266	1.113	2.776	5.224	9.716
Assumed Fill	0.754	4.126	14.021	26.810	63.996

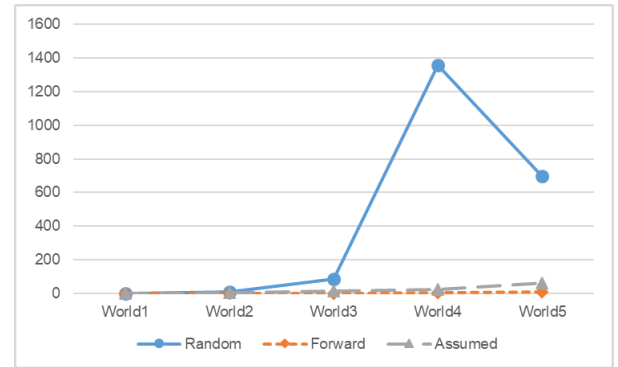

**FIGURE 8. Expected execution time accounting for failure rate per algorithm per world (ms). Lower is better.**

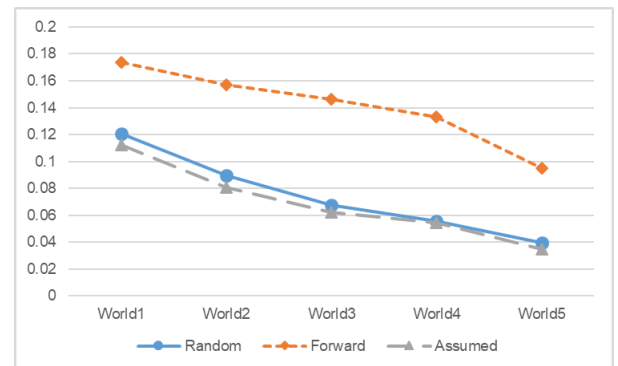

**FIGURE 9. Average bias per algorithm per world. Lower is better.**

multiple searching per fill iteration, shown in the Assumed Search pseudocode.

Now we will consider the expected execution time, shown in Table 5 and Fig. 8. When an expected execution time is calculated by considering the failure rate, Random Fill is still actually the lowest time expectancy for World 1. In Worlds 2 and 3, Random Fill's expected time is larger than either of the other two, but still not obscenely so. World 4 is where the failure rate grows so large that it is hardly comparable to the other two, taking 1356.6ms compared to Assumed Fill's 26.8ms, an increase of over 50 times. Because of the lower failure rate for World 5, the expected execution time for Random Fill in World 5 is actually less than in World 4, but is still over 10 times that of Assumed Fill.

For the following metrics, only successful placements of items within a world are considered.

First we will look at the bias, shown in Fig. 9. Random and Assumed Fill both having fairly low and close together bias while Forward Fill having consistently higher bias is expected. What is somewhat unexpected is that in each case,



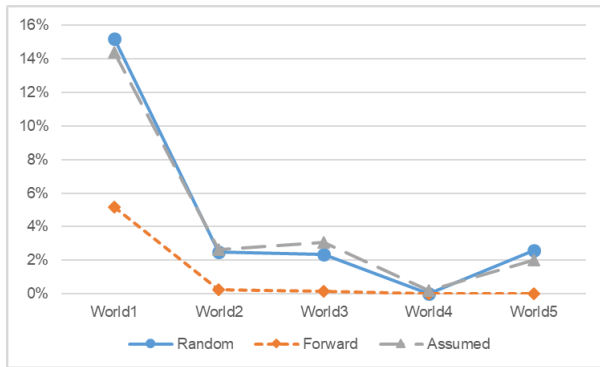

**FIGURE 10.** Percentage of time bias was toward the end of the game rather than toward the beginning per algorithm per world.

Assumed Fill actually gives slightly lower bias than Random Fill. This is a bit unintuitive, but an explanation is that while Assumed Fill is actively more likely to place key items in the later regions of the game (due to the entire world being placeable at the beginning and assumed search ensuring the reachability graph does not shrink too quickly), Random Fill has no such propensity, so whenever considering successful results only perhaps Random Fill is more likely to produce a successful result when it happens that more items are placed earlier compared to Assumed Fill. (If not considering successful results only, Random Fill’s bias is almost 0, but this is not a useful statistic.) It is also shown that, as the world becomes more complex, bias decreases across the board, likely due to having more opportunities to place items in the later regions of the game.

When calculating a number for bias, whether the bias was toward the beginning or end of the game is not considered: It simply calculates a number representing the inequality of distribution. Therefore while calculating this number we can also perform a check to see whether this inequality is toward the earlier or later regions of the game, with the former being much more common in all cases. Fig. 10 shows the percentage of time bias was toward the end rather than toward the beginning (so, for example, if the value is 5% then bias was toward the end 5% of the time and toward the beginning 95% of the time). It can be seen that bias being toward the end was a somewhat common occurrence for all three algorithms in World 1, being roughly a 5% chance for Forward Fill up to an almost 16% chance for Random Fill. This rate drops hard in the following worlds, going to almost 0% for Forward Fill and up to around 3% at most for Random and Assumed fill. World 4, in particular, has around 0% for all three algorithms, and the overall percentage does not seem to follow any particular pattern as complexity increases. It can then be assumed that whether the bias is more likely to be toward the end of the game is more a result of the design of the world itself rather than the complexity measure. However, it is still shown to be a less likely occurrence using Forward Fill.

Now we will consider interestingness, shown in Fig. 11. Note the measure on the side of the graph. All three



**FIGURE 11.** Average interestingness per algorithm per world. Higher is better.

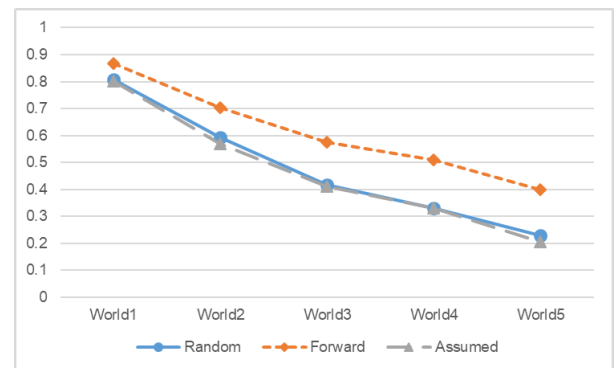

**FIGURE 12.** Average fun per algorithm per world. Higher is better.

algorithms are fairly close in their final interestingness score, in general with Forward Fill producing the least interesting result followed by Assumed which is very closely followed by Random. However, in World 5 Forward Fill suddenly jumps ahead of both of them. To understand why this happens, we must look more closely at the individual metrics composing interestingness. In general, Random Fill and Assumed Fill produce similar results for the individual metrics, while Forward Fill excels in different areas. Overall, interestingness falls as the worlds become more complex, likely due to more complex worlds meaning on average more traversals needed and more time required to make progress, even relative to the number of regions.

The graph for the fun metric is shown in Fig. 12. As expected, Forward Fill’s result is higher than the other two, while Random Fill barely edges out Assumed Fill in all cases. Due to Forward Fill producing world placements where key items are found earlier, it is easier for the player to make constant progress collecting item locations as they are less likely to be held back by a low number of currently owned items. Although the fun metric accounts for total number of locations when computing its threshold, more complex worlds are more likely to require the player to traverse for longer periods without checking item locations as they move around regions that have already been looted to get to ones that have not.

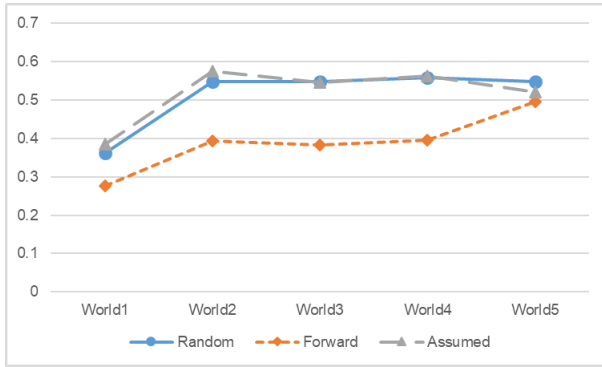

FIGURE 13. Average challenge per algorithm per world. Higher is better.

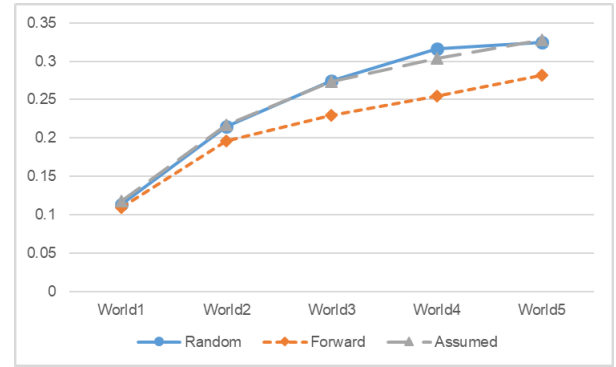

FIGURE 15. Average boredom per algorithm per world. Lower is better.

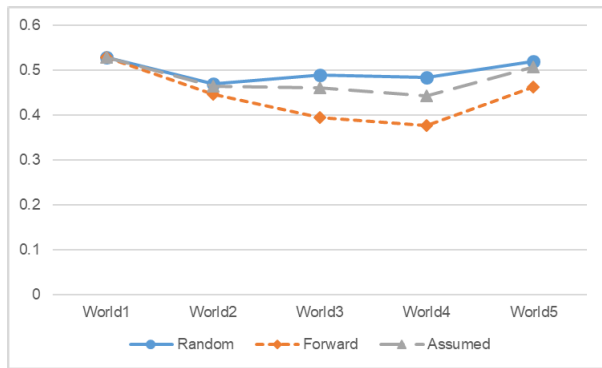

FIGURE 14. Average satisfyingness per algorithm per world. Higher is better.

Next we will observe the challenge metric in Fig. 13. Random and Assumed Fill are again very close in this metric, with Assumed Fill barely beating out Random Fill in the first two worlds and vice versa in the next three. However, the final challenge score seems to mostly plateau for these two algorithms starting at World 2. Forward Fill, on the other hand, is overall lower and similarly plateaus at World 2, however it has a sudden jump in challenge at World 5 that puts it almost even with Assumed Fill. This jump is certainly a large factor as to why Forward Fill’s final interestingness score beat out the other two in World 5. The reason for this jump in challenge is likely the same reason Forward Fill had a relatively high failure rate in World 5.

Next is satisfyingness, shown in Fig. 14. All three algorithms produced similar results for this metric, especially in World 1, but in all cases with Random Fill having the best score and Forward Fill having the worst score. The score is also mostly similar across each world, with the difference from the lowest to highest score being only.059,.135, and.086 for Random, Forward, and Assumed Fill respectively. Assumed Fill is again closer to the results of Random Fill than Forward Fill.

Finally we observe the results for boredom in Fig. 15. For this metric, Random and Assumed Fill’s results are so close together they are practically the same, besides a slight difference in World 4. Forward Fill is less boring on average, since finding key items earlier leads to overall fewer traversals as

the player is less likely to have to revisit regions after finding more items to clear them out. As complexity increases, boredom increases as well, likely for the same reason fun decreases: having a larger world will require more traversals as the player travels through regions that have already been searched to get to regions that have not yet been searched.

Overall, Forward Fill’s ability to stay ahead of the other two algorithms in the decreasing/increasing metrics of fun/boredom, while also having a sudden jump in challenge and somewhat of a sudden decrease in bias for World 5, allowed it to beat the other two in interestingness for World 5. While this result is worth noting, it does not necessarily mean that Forward Fill is the preferred algorithm for more complex worlds. Our method of world generation is not perfectly representative of a real game world and it is possible that a differently designed world of similar complexity would still have Random and Assumed Fill get a higher interestingness score than Forward Fill.

In general, Random and Assumed Fill perform better when considering bias, challenge, and satisfyingness, while Forward Fill performs better when considering fun and boredom. While we calculated interestingness using an equal 20% share for each metric, different weights could potentially be used. However, for the most part all that changing these weights would do is shift the graph to more strongly favor one of Random/Assumed Fill or Forward Fill.

## VII. DISCUSSION

Our goal was to provide generic implementations of the algorithms that did not have game-specific considerations. For example, while this work was inspired by the randomizer for *The Legend of Zelda: Ocarina of Time*, this game’s randomizer requires special considerations for the player’s age (child or adult) which modifies both what items the player can use and accessibility of certain edges (as the game world is somewhat changed in the player’s adult form). Traversal is also more complicated as the player is able to find items that allow them to warp to certain locations that may otherwise be inaccessible. Because of this goal of a generic implementation, we utilized randomly generated game worlds within our study to provide a rough approximation of what a designed

game world may look like. Results utilizing graphs of worlds from real games could be different, although we believe our overall findings would be consistent with real game worlds.

Another limitation, mentioned in the result evaluation subsection, is that our fun and boredom metrics considered for the interestingness score naturally favor smaller worlds, even though they account for the world size, as larger worlds are more likely to require the player to traverse regions that have already been searched to reach regions that have not been searched.

The heuristic utilized in PlaythroughSearch, meant to simulate the decision making of a real player, could be improved. High-level randomizer players don't just play the odds by heading toward where the most available locations are, they do what is called "reading logic" where they use their memorized knowledge of the game world's graph to predict where key items that are useful to them are likely to be located based on the placement of other items. Creating an algorithm to do this task would be non-trivial but would give a better approximation of a real player. This heuristic's parameters (such as the 17 - k divider to avoid backtracking) could be scaled to depend on the size of the world.

While our expected time to compute a successful item placement using Random Fill considers if each iteration of the algorithm is run linearly, a parallelized implementation could be utilized to produce a result much faster, especially if the code for the randomizer is hosted on servers.

Our desire was to have at least a few dozen successful results from Random Fill over 100,000 iterations of the algorithm on each world. Due to this, even our most complex world's complexity pales in comparison to the complexity of some real game worlds, such as *Ocarina of Time*'s world, which has hundreds of regions and some edge rule clauses that are several lines long.

Although we considered implementing it outside of the scope of this research, one could theoretically make a modified version of Forward Fill or Assumed Fill that is guaranteed to not fail (as long as the input is valid) by checking if the algorithm is expected to hit a "dead end" and figuring out what items need to be placed soon to avoid this dead end. It would be trivial to check if only one available location is left and one item can be used to open up more so the algorithm knows that item should be placed there. However, if multiple items are required to open more locations and perhaps not many locations are opened up such that more items need to be placed to open up the world than locations that become available, the check for such situations would become increasingly complex. We believe the performance hit of such an algorithm would not be economical when a failed Assumed or Forward Fill run can just be re-done and almost certainly work the second time, but if such an occurrence is considered unacceptable or the game world has a high chance of failure for some reason, then these modified algorithms could potentially be useful.

One could also create a modification of Forward Fill which, after running the algorithm, performs some post-fill

operations to further shuffle items to attempt to create more interesting placements. The effect this has on the outcome of the interestingness metrics could then be studied and compared to Forward Fill only and the other fill algorithms.

## VIII. CONCLUSION

In this paper, we have defined three algorithms for use in randomizing key item placement within a game world, as well as several search algorithms utilized either within the fill algorithms or to determine some properties of a resulting placement. We have defined metrics to calculate the complexity of a given game world and the bias and interestingness of a game world whose locations have been filled with items.

We have evaluated the three fill algorithms using five worlds of increasing complexity. We believe the results of these experiments can provide some guidance to an aspiring randomizer developer on which algorithm works best for the game for which they want to create a randomizer. In particular, we give the following advice.

- 1) If faster, easier playthroughs where progress is constantly being made are desired, utilize Forward Fill.
- 2) If longer, more challenging playthroughs that require more exploration and backtracking are desired, utilize Random Fill or Assumed Fill.
  - a) If the game world is small and simple enough that the expected execution time for Random Fill to produce a completable result is reasonable, then Random Fill will give an overall better result for this goal.
  - b) If the game world is large and complex so that Random Fill could take unreasonable amounts of time to produce a completable result, then Assumed Fill gives a very close approximation of the quality provided by Random Fill, so Assumed Fill is a good choice in this case.

## ACKNOWLEDGMENT

Caleb H. Johnson would like to thank the developers, staff, and community of the randomizer for *The Legend of Zelda: Ocarina of Time*, especially the lead developer Aharon Turpie, for introducing him to randomizer algorithms and their help and guidance during the creation of this work.

## REFERENCES

- [1] J. Dormans and S. Bakkes, "Generating missions and spaces for adaptable play experiences," *IEEE Trans. Comput. Intell. AI in Games*, vol. 3, no. 3, pp. 216–228, Sep. 2011.
- [2] M. Cook and A. Raad, "Hyperstate space graphs for automated game analysis," in *Proc. IEEE Conf. Games (CoG)*, London, U.K., Aug. 2019, pp. 1–8.
- [3] D. Karavolos, A. Liapis, and G. N. Yannakakis, "Evolving missions to create game spaces," in *Proc. IEEE Conf. Comput. Intell. Games (CIG)*, Sep. 2016, pp. 1–8.
- [4] A. Liapis, G. N. Yannakakis, and J. Togelius, "Towards a generic method of evaluating game levels," in *Proc. AAAI Artif. Intell. Interact. Digit. Entertainment Conf.*, Nov. 2013, pp. 1–7.
- [5] A. S. Nugraha, A. Setiawan, and W. Wijanarto, "Automatic power-up items placement on shooter game using convolutional neural network," *J. Appl. Intell. Syst.*, vol. 5, no. 1, pp. 47–56, Dec. 2020.

- [6] C. Pedersen, J. Togelius, and G. N. Yannakakis, "Modeling player experience for content creation," *IEEE Trans. Comput. Intell. AI in Games*, vol. 2, no. 1, pp. 54–67, Mar. 2010.
- [7] J. Lehman and K. O. Stanley, "Beyond open-endedness: Quantifying impressiveness," in *Proc. 13th Int. Conf. Simul. Synth. Living Syst. (Artificial Life)*, 2012, pp. 75–82.
- [8] S. A. Roberts and S. M. Lucas, "Measuring interestingness of continuous game problems," in *Proc. IEEE Conf. Comput. Intell. Games (CIG)*, Aug. 2013, pp. 1–8.
- [9] S. Porchia. *The Legend of Zelda: A Link to the Past VT Randomizer*. GitHub Repository. Accessed: Mar. 20, 2021. [Online]. Available: [https://github.com/sporchia/alttp\\_vt\\_randomizer](https://github.com/sporchia/alttp_vt_randomizer)
- [10] A. Turpie. *The Legend of Zelda: Ocarina of Time Randomizer*. GitHub Repository. Accessed: Mar. 20, 2021. [Online]. Available: <https://github.com/TestRunnerSRL/OoT-Randomizer>
- [11] G. D. Quick. Feb. 11, 2019. *Making a Randomizer*. Youtube Video. [Online]. Available: <https://youtu.be/vGIDzGvsrV8>
- [12] Anatomyz. Aug. 12, 2018. *Ocarina of Time Randomizer Routing Tutorial*. Youtube Video. [Online]. Available: <https://youtu.be/VpvZhm0Hx5Q>
- [13] C. Johnson. *Randomizer Algorithms*. GitHub Repository. Accessed: Mar. 20, 2021. [Online]. Available: <https://github.com/cjohnson57/RandomizerAlgorithms/tree/v1.0.0>



**CALEB H. JOHNSON** was born in Baton Rouge, LA, USA, in 1998. He received the B.S. degree in computer engineering from Louisiana State University, Baton Rouge, in 2020, where he is currently pursuing the M.S. degree in computer engineering.

Since 2017, he has been working with the Louisiana State University's Center for Analytics and Research in Transportation Safety as a Developer and a Computer Analyst. His research

interests include application development, website development (front-end and back-end), and data analysis.



**JERRY L. TRAHAN** (Member, IEEE) received the B.S. degree from Louisiana State University, in 1983, and the M.S. and Ph.D. degrees from the University of Illinois at Urbana-Champaign, in 1986 and 1988, respectively. Since 1988, he has been a Faculty Member with the Division of Electrical & Computer Engineering, Louisiana State University, where he is currently the Chair and the Chevron Associate Professor of Electrical Engineering. His research interests include algorithms, models of parallel computation, theory of computation, RFID protocols, and robot algorithms.



**TAO LU** received the B.S.E.E. degree from Beihang University (BUAA), China, and the M.S.E.E. degree from the University of Southern California (USC), Los Angeles, CA, USA. He is currently pursuing the Ph.D. degree in computer engineering with Louisiana State University (LSU). His research interests include computer architecture, domain-specific accelerator, and blockchain technology and applications. His article on blockchain acceleration is published on DAC 2020. He has done internship in Xilinx CTO Lab and works on advanced FPGA-based blockchain acceleration projects.



**LU PENG** (Senior Member, IEEE) received the bachelor's and master's degrees in computer science and engineering from Shanghai Jiao Tong University, Shanghai, China, and the Ph.D. degree in computer engineering from the University of Florida, Gainesville, FL, USA. He is currently the Gerard L. "Jerry" Rispone Professor with the Division of Electrical and Computer Engineering, Louisiana State University, Baton Rouge, LA, USA. His current research interests include memory hierarchy systems, reliability, power efficiency, and other issues in processor design. He is also a Senior Member of ACM. He was a recipient of the ORAU Ralph E. Power Junior Faculty Enhancement Awards in 2007 and the Best Paper Award from IEEE International Green and Sustainable Computing Conference (IGSC) in 2019 and IEEE International Conference on Computer Design (ICCD) processor architecture track in 2001.

...