

CS 5633 -- Spring 2010

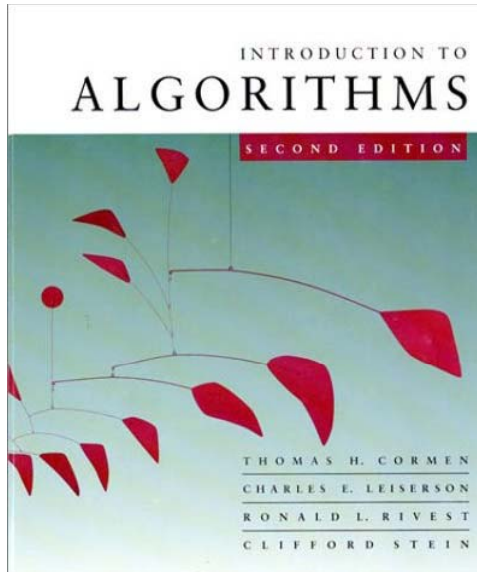

Union-Find Data Structures

Carola Wenk

Slides courtesy of Charles Leiserson with small changes by Carola Wenk

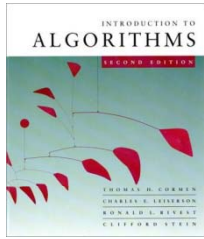

Disjoint-set data structure (Union-Find)

Problem:

- Maintain a dynamic collection of *pairwise-disjoint* sets $\mathcal{S} = \{S_1, S_2, \dots, S_r\}$.
- Each set S_i has one element distinguished as the representative element, $rep[S_i]$.
- Must support 3 operations:
 - **MAKE-SET**(x): adds new set $\{x\}$ to \mathcal{S}
with $rep[\{x\}] = x$ (for any $x \notin S_i$ for all i)
 - **UNION**(x, y): replaces sets S_x, S_y with $S_x \cup S_y$ in \mathcal{S}
(for any x, y in distinct sets S_x, S_y)
 - **FIND-SET**(x): returns representative $rep[S_x]$
of set S_x containing element x

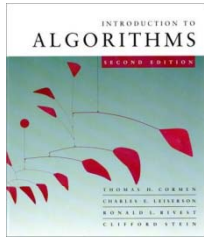

Union-Find Example

MAKE-SET(2)

MAKE-SET(3)

MAKE-SET(4)

FIND-SET(4) = 4

UNION(2, 4)

FIND-SET(4) = 2

MAKE-SET(5)

UNION(4, 5)

$S = \{\}$

$S = \{\{\underline{2}\}\}$

$S = \{\{\underline{2}\}, \{\underline{3}\}\}$

$S = \{\{\underline{2}\}, \{\underline{3}\}, \{\underline{4}\}\}$

$S = \{\{\underline{2}, 4\}, \{\underline{3}\}\}$

$S = \{\{\underline{2}, 4\}, \{\underline{3}\}, \{\underline{5}\}\}$

$S = \{\{\underline{2}, 4, 5\}, \{\underline{3}\}\}$

The representative is underlined

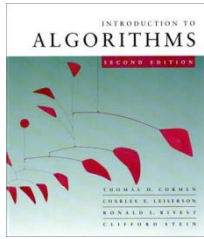

Application: Dynamic connectivity

Suppose a graph is given to us *incrementally* by

- $\text{ADD-VERTEX}(v)$
- $\text{ADD-EDGE}(u, v)$

and we want to support *connectivity* queries:

- $\text{CONNECTED}(u, v)$:

Are u and v in the same connected component?

For example, we want to maintain a spanning forest, so we check whether each new edge connects a previously disconnected pair of vertices.

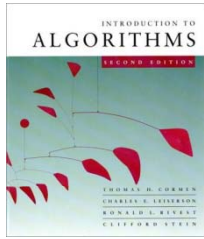

Application: Dynamic connectivity

Sets of vertices represent connected components.

Suppose a graph is given to us *incrementally* by

- $\text{ADD-VERTEX}(v) : \text{MAKE-SET}(v)$
- $\text{ADD-EDGE}(u, v) : \mathbf{if}$ not $\text{CONNECTED}(u, v)$
then $\text{UNION}(u, v)$

and we want to support *connectivity* queries:

- $\text{CONNECTED}(u, v) : \text{FIND-SET}(u) = \text{FIND-SET}(v)$

Are u and v in the same connected component?

For example, we want to maintain a spanning forest, so we check whether each new edge connects a previously disconnected pair of vertices.

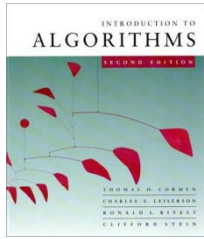

Disjoint-set data structure (Union-Find) II

- In all operations pointers to the elements x , y in the data structure are given.
- Hence, we do not need to first search for the element in the data structure.
- Let n denote the overall number of elements (equivalently, the number of MAKE-SET operations).

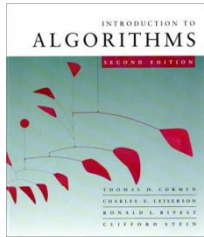

Simple linked-list solution

Store each set $S_i = \{x_1, x_2, \dots, x_k\}$ as an (unordered) doubly linked list. Define representative element $rep[S_i]$ to be the front of the list, x_1 .

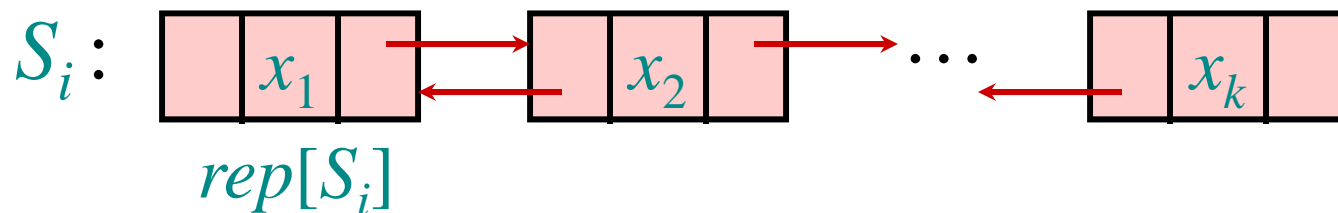

- $\Theta(1)$ • MAKE-SET(x) initializes x as a lone node.
- $\Theta(n)$ • FIND-SET(x) walks left in the list containing x until it reaches the front of the list.
- $\Theta(n)$ • UNION(x, y) calls FIND-SET on y , finds the last element of list x , and concatenates both lists, leaving $rep.$ as FIND-SET[x].

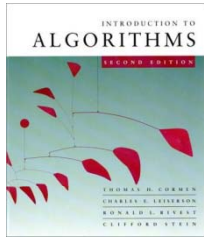

Simple balanced-tree solution

maintain how?

Store each set $S_i = \{x_1, x_2, \dots, x_k\}$ as a balanced tree (ignoring keys). Define representative element $rep[S_i]$ to be the root of the tree.

- $\Theta(1)$ • MAKE-SET(x) initializes x as a lone node.
- $\Theta(\log n)$ • FIND-SET(x) walks up the tree containing x until reaching root.
- $\Theta(\log n)$ • UNION(x, y) calls FIND-SET on y , finds a leaf of x and concatenates both trees, changing rep. of y

$S_i = \{x_1, x_2, x_3, x_4, x_5\}$

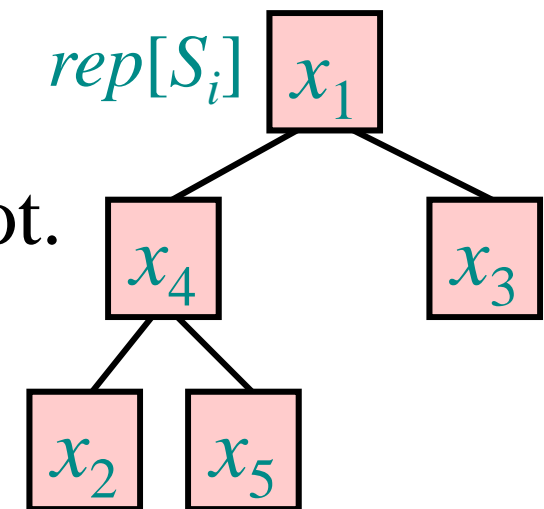

How?

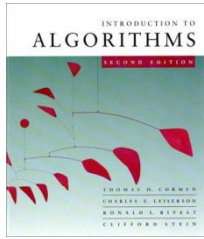

Plan of attack

- We will build a simple disjoint-union data structure that, in an **amortized sense**, performs significantly better than $\Theta(\log n)$ per op., even better than $\Theta(\log \log n)$, $\Theta(\log \log \log n)$, ..., but not quite $\Theta(1)$.
- To reach this goal, we will introduce two key *tricks*. Each trick converts a trivial $\Theta(n)$ solution into a simple $\Theta(\log n)$ amortized solution. Together, the two tricks yield a much better solution.
- First trick arises in an augmented linked list. Second trick arises in a tree structure.

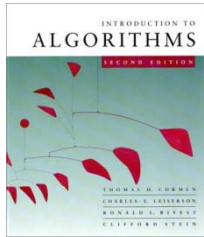

Augmented linked-list solution

Store $S_i = \{x_1, x_2, \dots, x_k\}$ as unordered doubly linked list.

Augmentation: Each element x_j also stores pointer $rep[x_j]$ to $rep[S_i]$ (which is the front of the list, x_1).

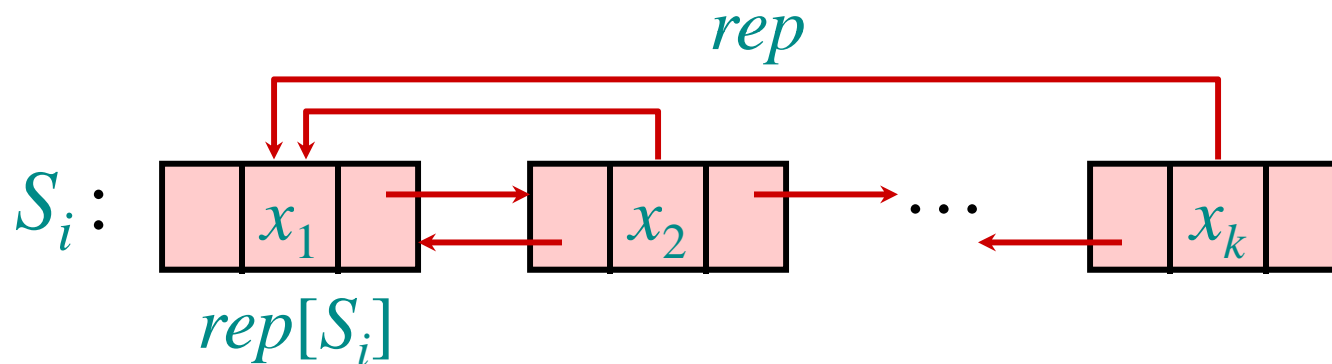

- FIND-SET(x) returns $rep[x]$. – $\Theta(1)$
- UNION(x, y) concatenates lists containing x and y and updates the rep pointers for all elements in the list containing y . – $\Theta(n)$

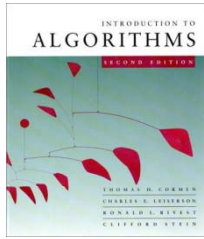

Example of augmented linked-list solution

Each element x_j stores pointer $rep[x_j]$ to $rep[S_i]$.

UNION(x, y)

- concatenates the lists containing x and y , and
- updates the rep pointers for all elements in the list containing y .

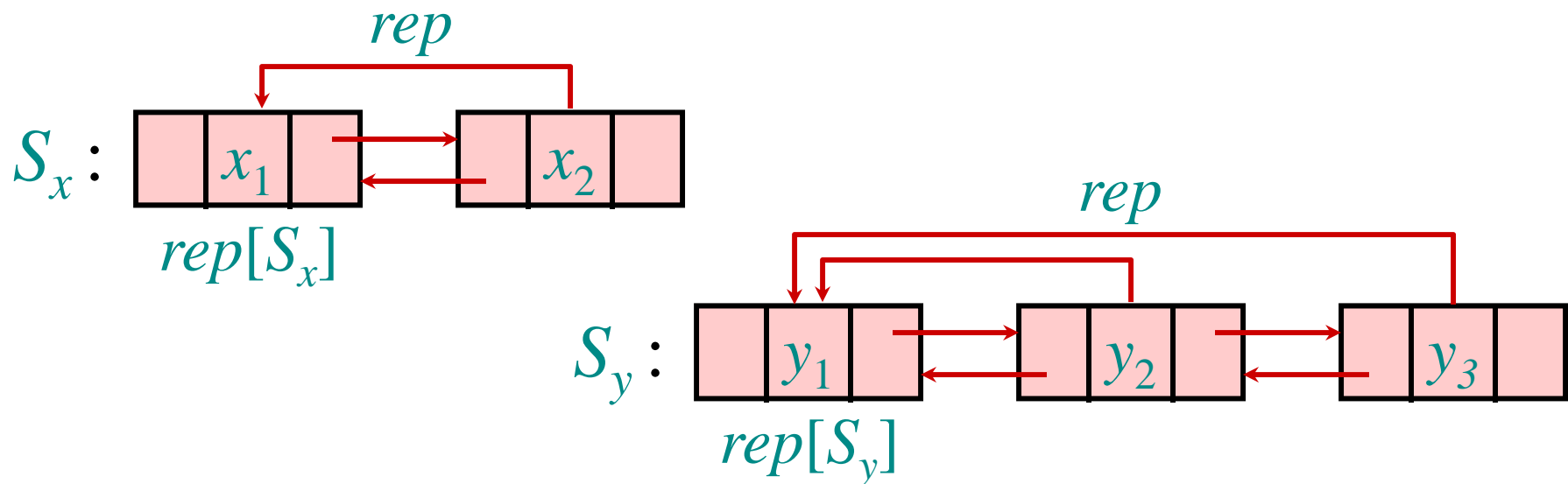

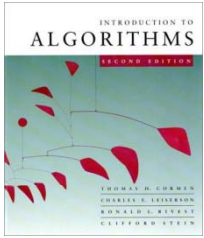

Example of augmented linked-list solution

Each element x_j stores pointer $rep[x_j]$ to $rep[S_i]$.

UNION(x, y)

- concatenates the lists containing x and y , and
- updates the rep pointers for all elements in the list containing y .

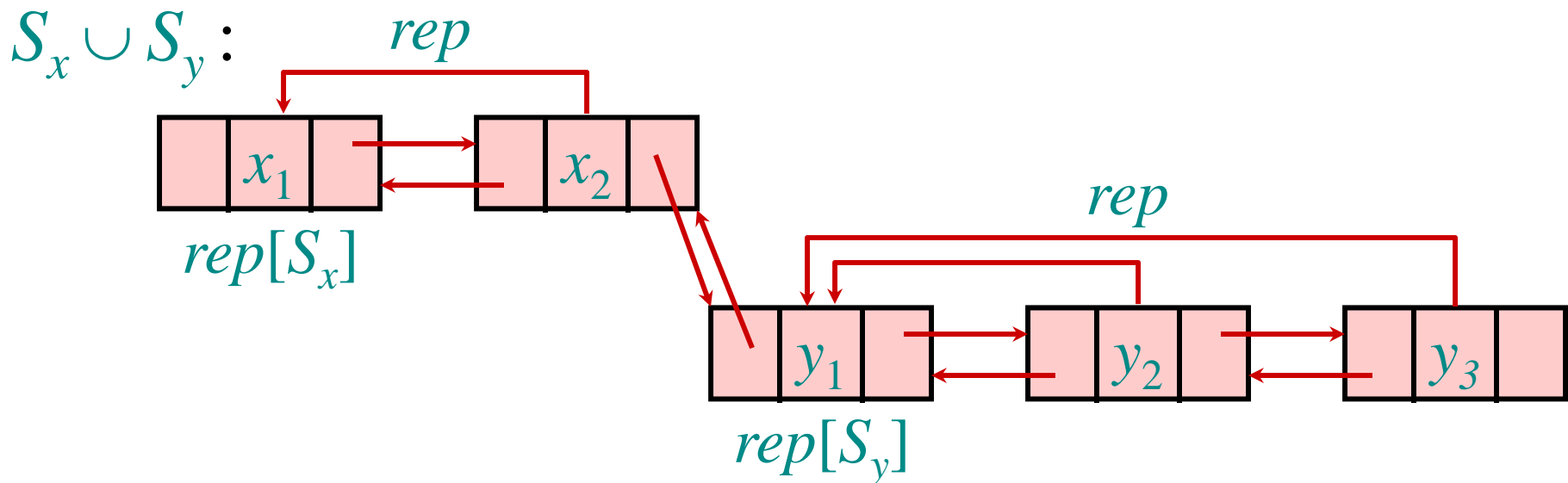

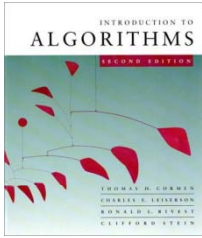

Example of augmented linked-list solution

Each element x_j stores pointer $rep[x_j]$ to $rep[S_i]$.

UNION(x, y)

- concatenates the lists containing x and y , and
- updates the rep pointers for all elements in the list containing y .

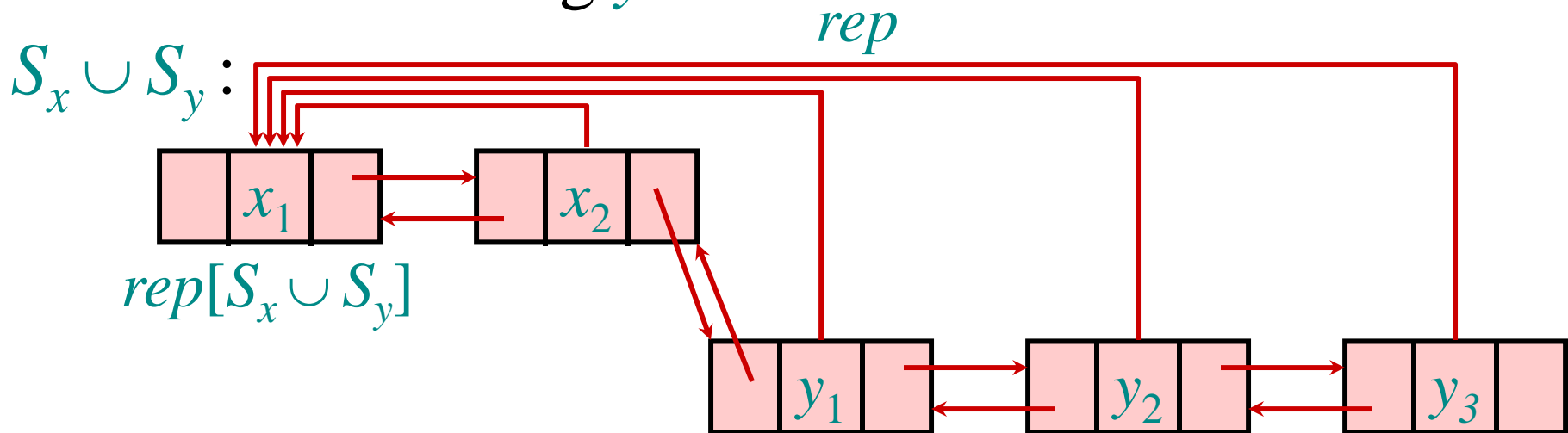

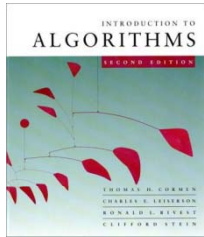

Alternative concatenation

UNION(x , y) could instead

- concatenate the lists containing y and x , and
- update the *rep* pointers for all elements in the list containing x .

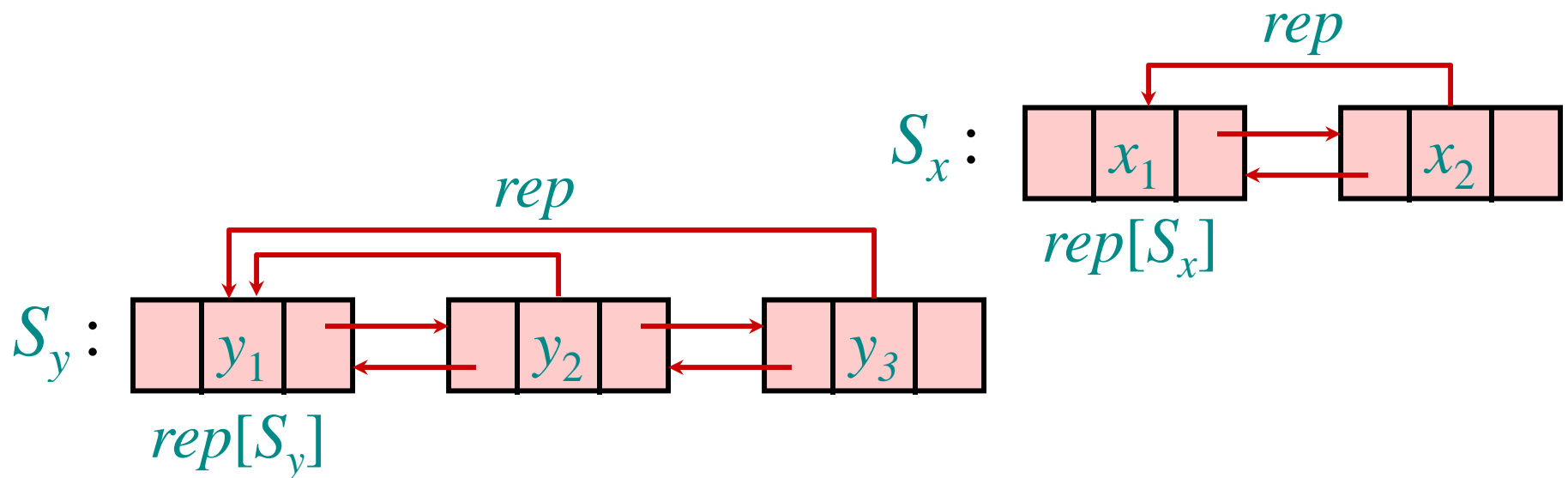

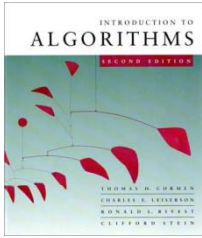

Alternative concatenation

UNION(x, y) could instead

- concatenate the lists containing y and x , and
- update the *rep* pointers for all elements in the list containing x .

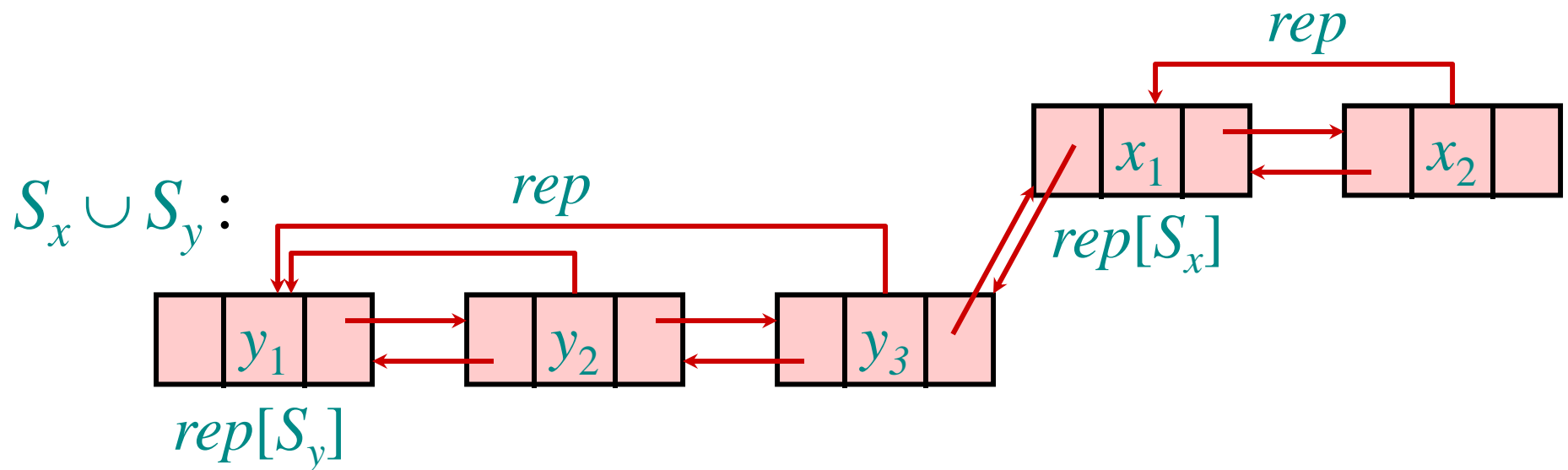

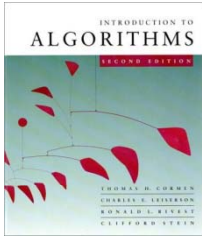

Alternative concatenation

UNION(x, y) could instead

- concatenate the lists containing y and x , and
- update the *rep* pointers for all elements in the list containing x .

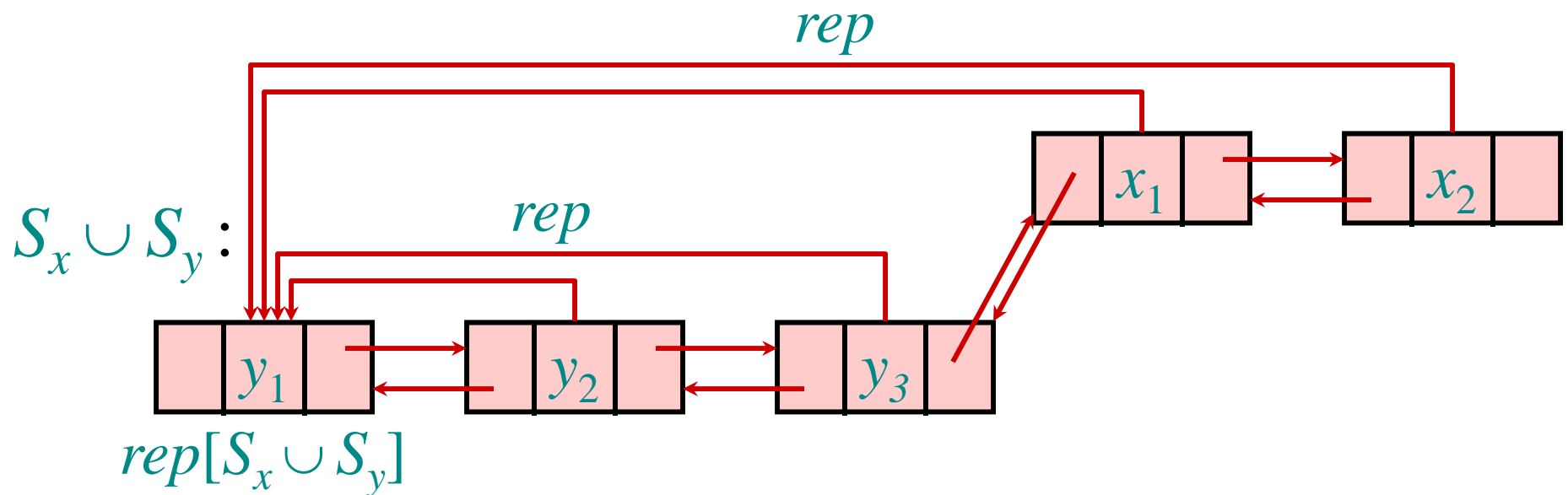

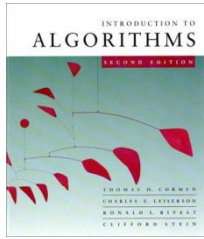

Trick 1: Smaller into larger **(weighted-union heuristic)**

To save work, concatenate the smaller list onto the end of the larger list. Cost = Θ (length of smaller list). Augment list to store its *weight* (# elements).

- Let n denote the overall number of elements (equivalently, the number of MAKE-SET operations).
- Let m denote the total number of operations.
- Let f denote the number of FIND-SET operations.

Theorem: Cost of all UNION's is $O(n \log n)$.

Corollary: Total cost is $O(m + n \log n)$.

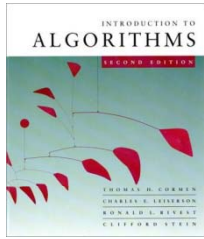

Analysis of Trick 1 (weighted-union heuristic)

Theorem: Total cost of UNION's is $O(n \log n)$.

- Proof.*
- Monitor an element x and set S_x containing it.
 - After initial MAKE-SET(x), $weight[S_x] = 1$.
 - Each time S_x is united with S_y :
 - if $weight[S_y] \geq weight[S_x]$:
 - pay 1 to update $rep[x]$, and
 - $weight[S_x]$ at least doubles (increases by $weight[S_y]$).
 - if $weight[S_y] < weight[S_x]$:
 - pay nothing, and
 - $weight[S_x]$ only increases.

Thus $pay \leq \log n$ for x .



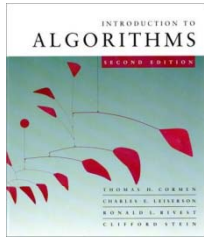

Disjoint set forest: Representing sets as trees

Store each set $S_i = \{x_1, x_2, \dots, x_k\}$ as an unordered, potentially unbalanced, not necessarily binary tree, storing only *parent* pointers. $rep[S_i]$ is the tree root.

- MAKE-SET(x) initializes x as a lone node. — $\Theta(1)$
- FIND-SET(x) walks up the tree containing x until it reaches the root. — $\Theta(depth[x])$
- UNION(x, y) calls FIND-SET twice and concatenates the trees containing x and y ... — $\Theta(depth[x])$

$$S_i = \{x_1, x_2, x_3, x_4, x_5, x_6\}$$

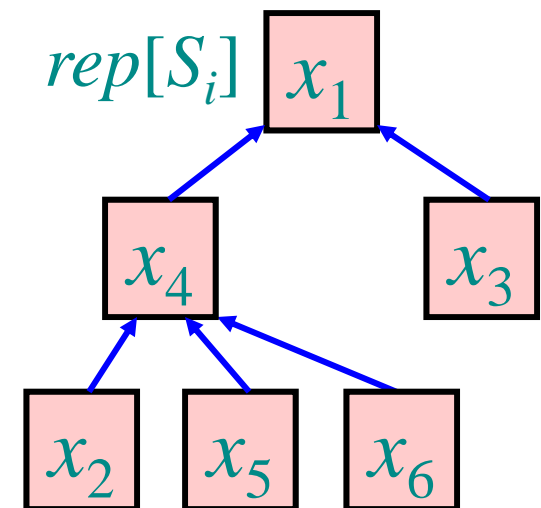

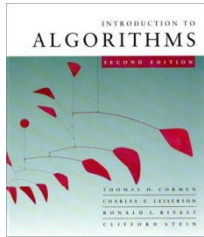

Trick 1 adapted to trees

- $\text{UNION}(x, y)$ can use a simple concatenation strategy: Make root $\text{FIND-SET}(y)$ a child of root $\text{FIND-SET}(x)$.
 $\Rightarrow \text{FIND-SET}(y) = \text{FIND-SET}(x)$.

- Adapt Trick 1 to this context:

Union-by-weight:

Merge tree with smaller weight into tree with larger weight.

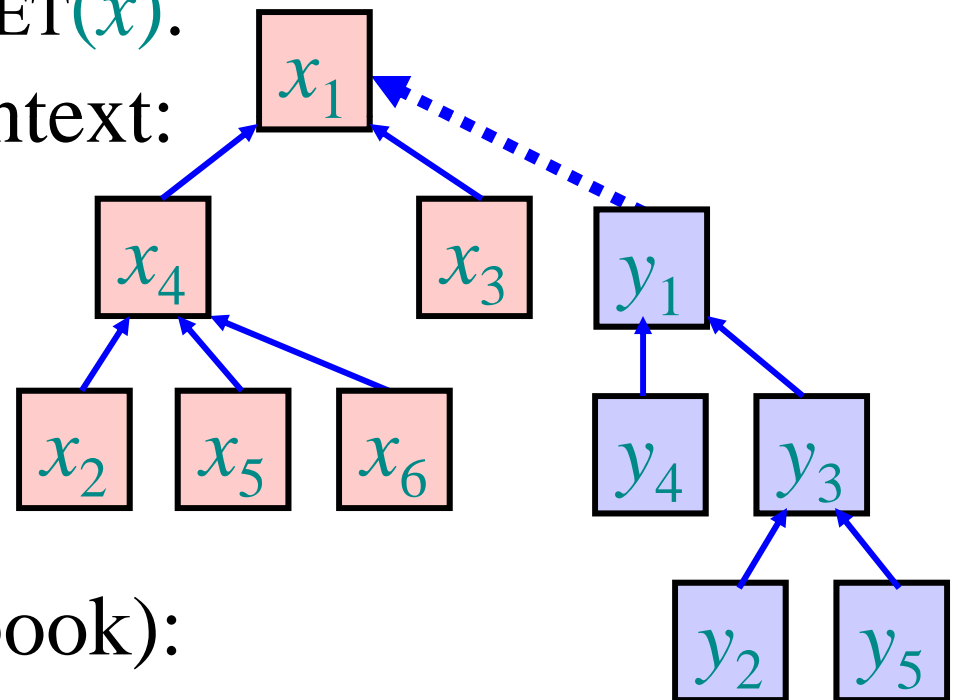

- Variant of Trick 1 (see book):

Union-by-rank:

rank of a tree = its height

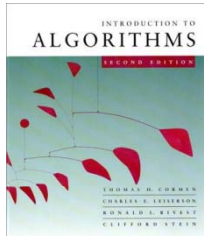

Trick 1 adapted to trees (union-by-weight)

- Height of tree is logarithmic in weight, because:
 - Induction on n
 - Height of a tree T is determined by the two subtrees T_1, T_2 that T has been united from.
 - Inductively the heights of T_1, T_2 are the logs of their weights.
 - If T_1 and T_2 have different heights:
$$\begin{aligned}\text{height}(T) &= \max(\text{height}(T_1), \text{height}(T_2)) \\ &= \max(\log \text{weight}(T_1), \log \text{weight}(T_2)) \\ &< \log \text{weight}(T)\end{aligned}$$
 - If T_1 and T_2 have the same heights:
(Assume $2 \leq \text{weight}(T_1) < \text{weight}(T_2)$)
$$\begin{aligned}\text{height}(T) &= \text{height}(T_1) + 1 = \log(2 * \text{weight}(T_1)) \\ &\leq \log \text{weight}(T)\end{aligned}$$
- Thus the total cost of any m operations is $O(m \log n)$.

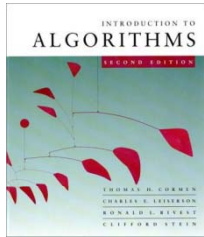

Trick 2: Path compression

When we execute a FIND-SET operation and walk up a path p to the root, we know the representative for all the nodes on path p .

Path compression makes all of those nodes direct children of the root.

Cost of FIND-SET(x) is still $\Theta(\text{depth}[x])$.

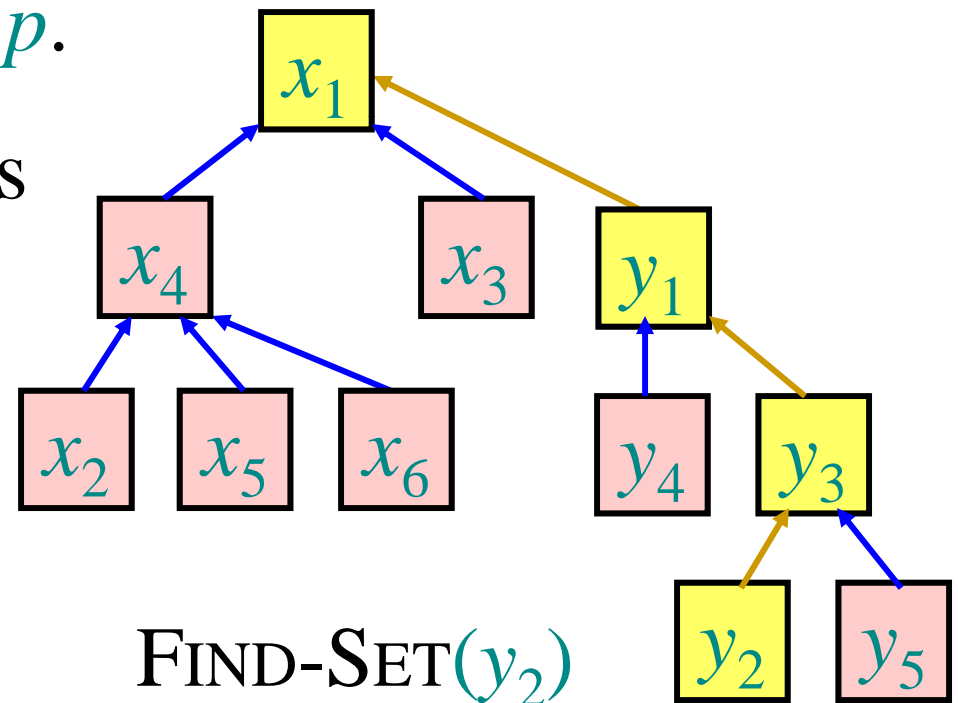

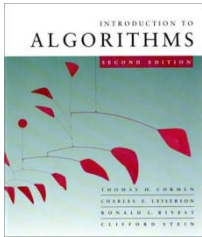

Trick 2: Path compression

When we execute a FIND-SET operation and walk up a path p to the root, we know the representative for all the nodes on path p .

Path compression makes all of those nodes direct children of the root.

Cost of FIND-SET(x) is still $\Theta(\text{depth}[x])$.

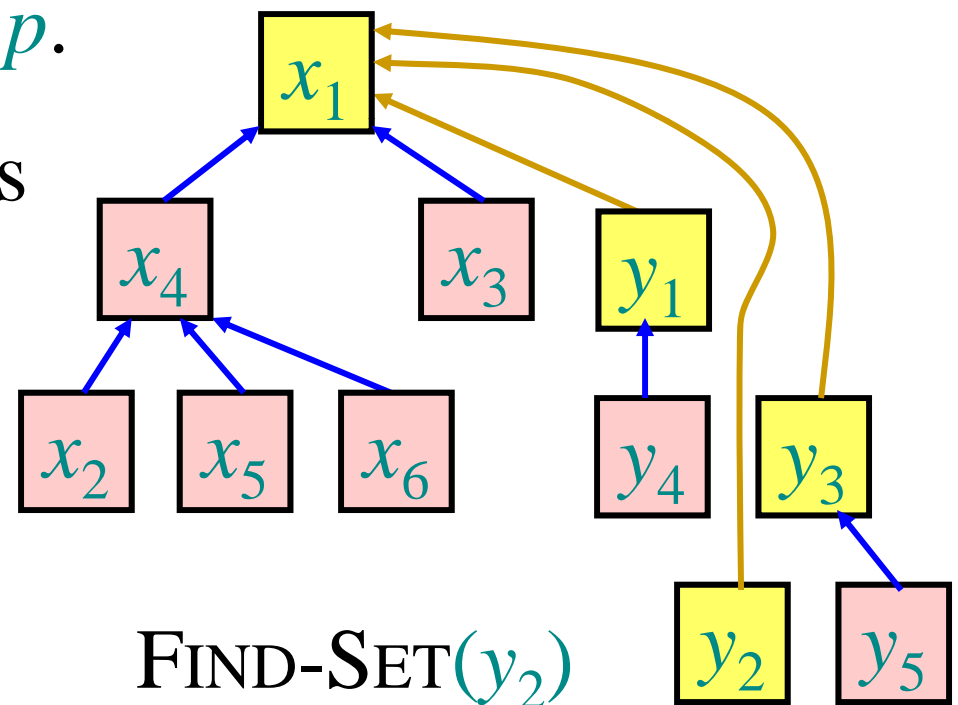

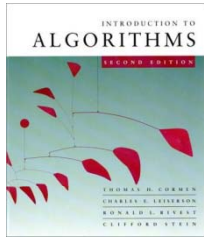

Trick 2: Path compression

When we execute a FIND-SET operation and walk up a path p to the root, we know the representative for all the nodes on path p .

Path compression makes all of those nodes direct children of the root.

Cost of FIND-SET(x) is still $\Theta(\text{depth}[x])$.

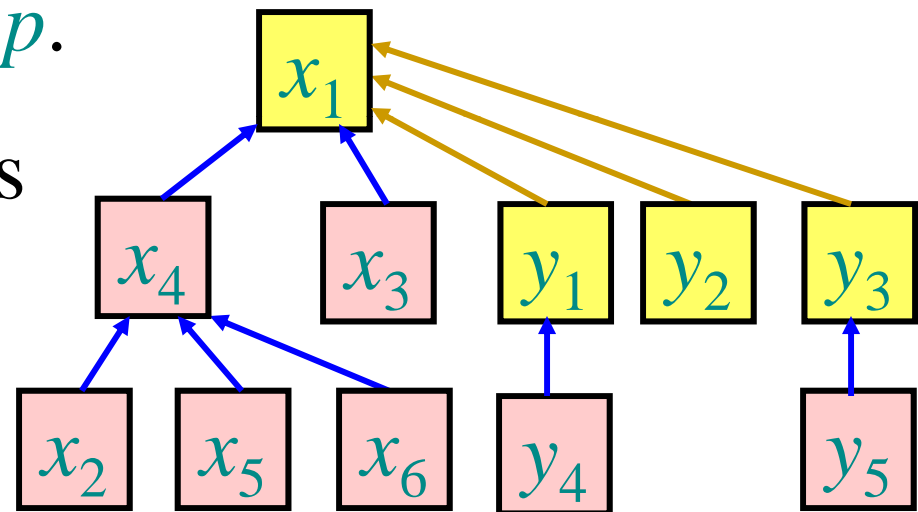

FIND-SET(y_2)

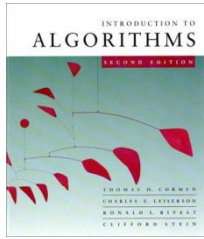

Trick 2: Path compression

- Note that $\text{UNION}(x, y)$ first calls $\text{FIND-SET}(x)$ and $\text{FIND-SET}(y)$. Therefore path compression also affects UNION operations.

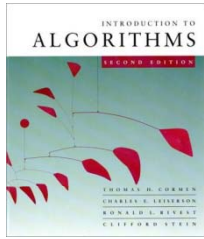

Analysis of Trick 2 alone

Theorem: Total cost of FIND-SET's is $O(m \log n)$.

Proof: By amortization. Omitted.

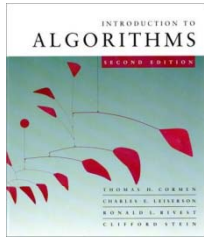

Ackermann's function A , and its "inverse" α

Define $A_k(j) = \begin{cases} j+1 & \text{if } k=0, \\ A_{k-1}^{(j+1)}(j) & \text{if } k \geq 1. \end{cases}$ – iterate $j+1$ times

$$A_0(j) = j + 1$$

$$A_0(1) = 2$$

$$A_1(j) \sim 2j$$

$$A_1(1) = 3$$

$$A_2(j) \sim 2j \cdot 2^j > 2^j$$

$$A_2(1) = 7$$

$$A_3(1) = 2047$$

$$A_3(j) > 2^{2^{2^{\dots^{2^j}}}}$$

$A_4(j)$ is a lot bigger.

$$A_4(1) > 2^{2^{2^{\dots^{2^{2047}}}}}$$

2048 times

Define $\alpha(n) = \min \{k : A_k(1) \geq n\} \leq 4$ for practical n .

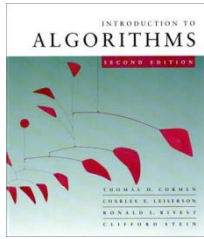

Analysis of Tricks 1 + 2 for disjoint-set forests

Theorem: In general, total cost is $O(m \alpha(n))$.
(long, tricky proof – see Section 21.4 of CLRS)